

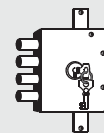

Pin, muzzle and “Cadorine” keys
Chiavi a gorges, grugno e “Cadorine”
Gorges-, Faust- und Cadorineschlüssel
Clés à gorges, à groin et “Cadorine”
Llaves a gorges, a puño y “Cadorine”
Chaves tipo gorges, “Grugno” e “Cadorine”

FOR:
PER: **ALDRIDGE**

ALEDAL



83

FOR/PER

ALDRIDGE (GB)

ALEDAL (S)

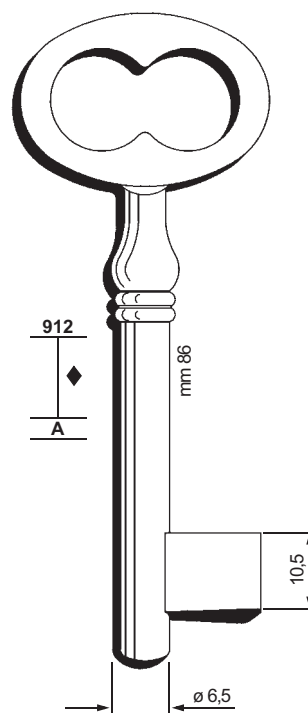
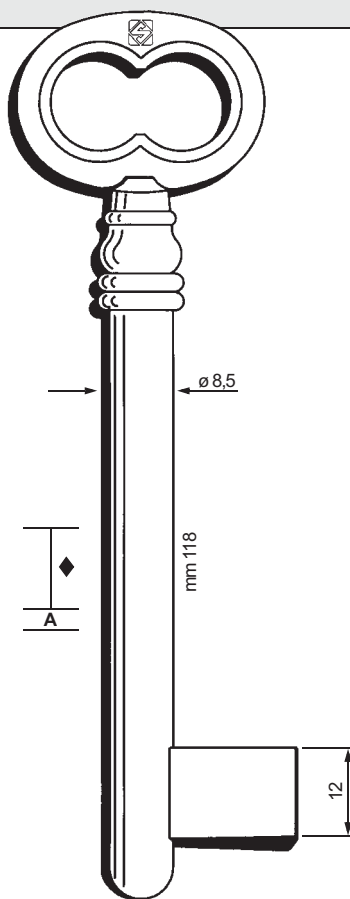
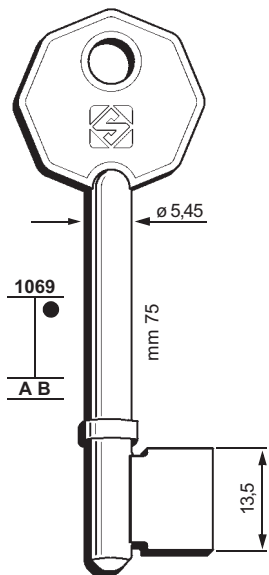

FOR:
PER:

ALEDAL

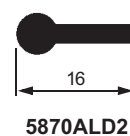
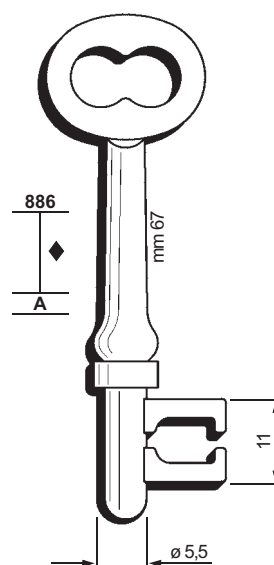
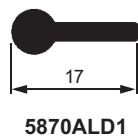
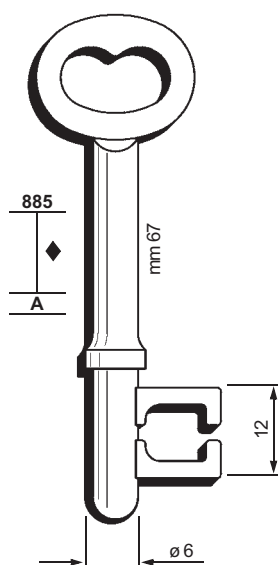
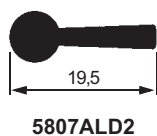
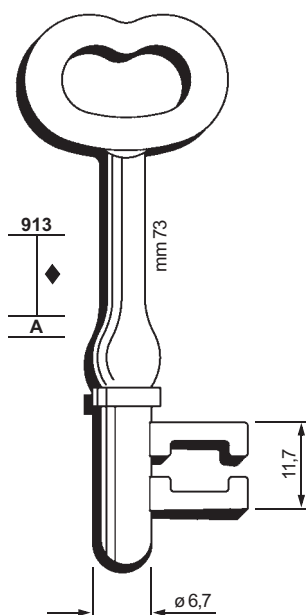

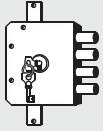

84

FOR/PER

ALEDAL (S)

ANCHOR (S)

AVA CHUBB (85)

ARCU (E)

ASSA (S)

FOR:
PER:

ALEDAL

ARCU

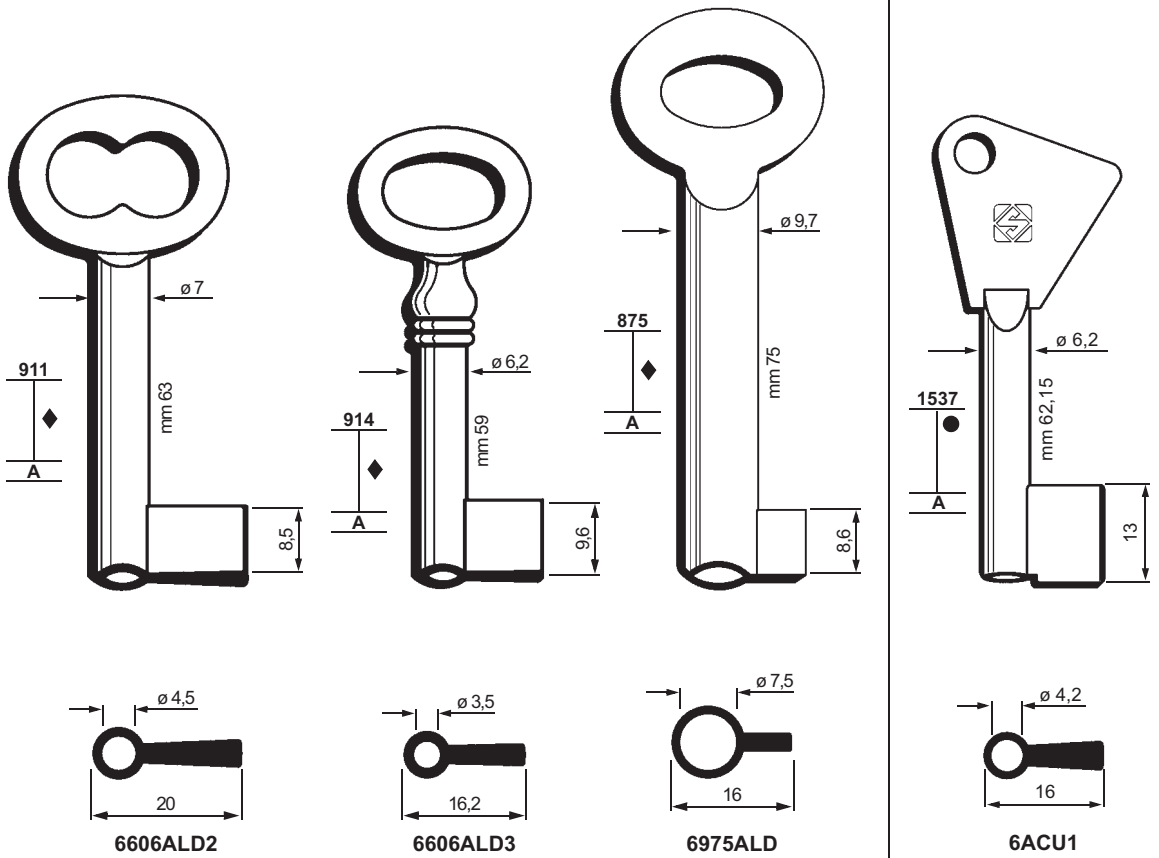

FOR:
PER:

ASSA

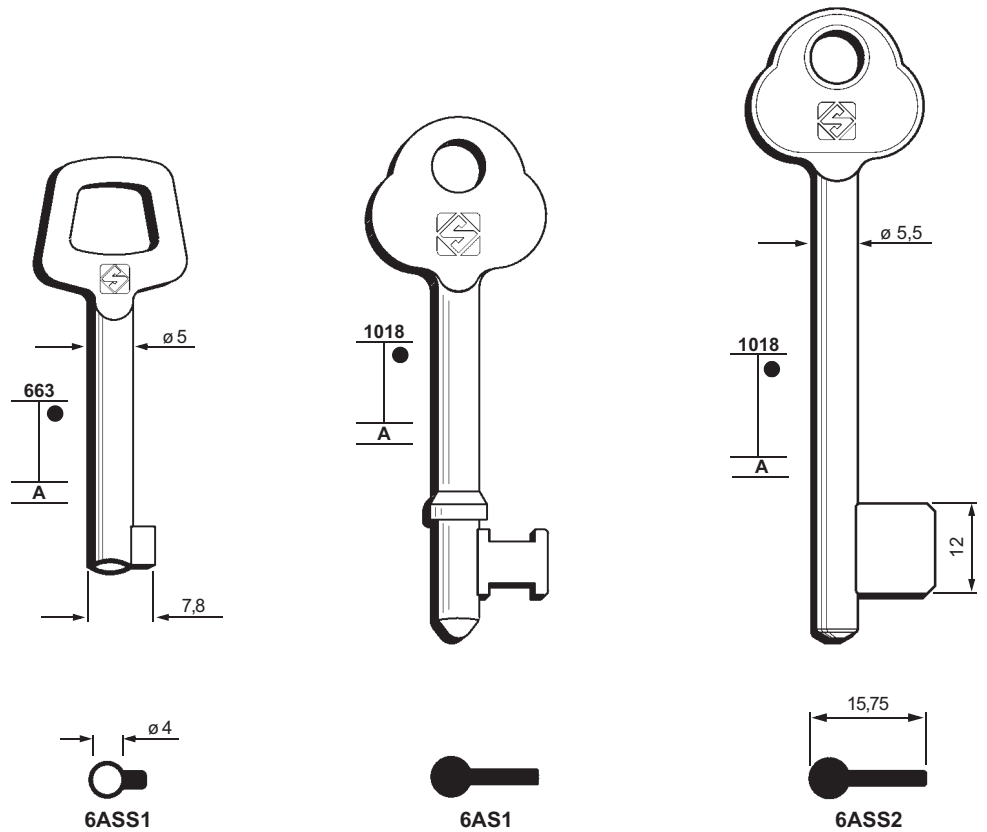

FOR:
PER:

AVA-CHUBB

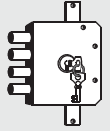

85

FOR/PER

AVA-CHUBB (S)
ANCHOR

BKS (D)

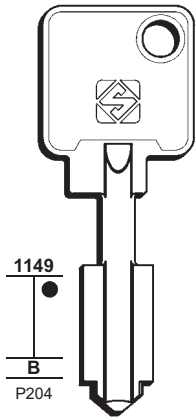

5ACH4

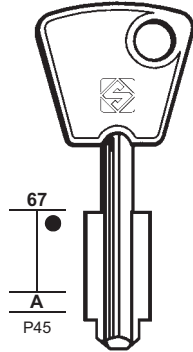

ACH

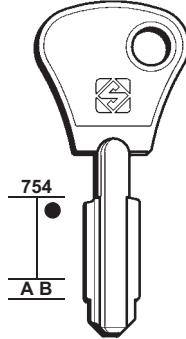

5ACH1

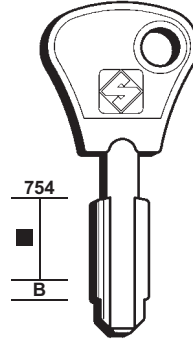

5ACH3

ANCHOR

FOR:
PER:

AVA-CHUBB

BKS

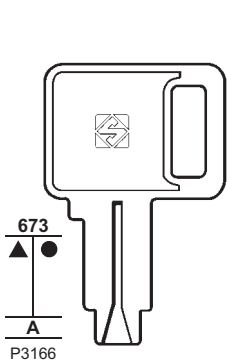

CHU5

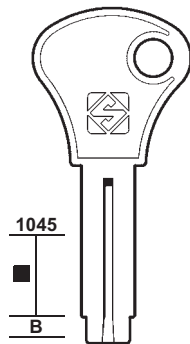

CHU7

ANCHOR

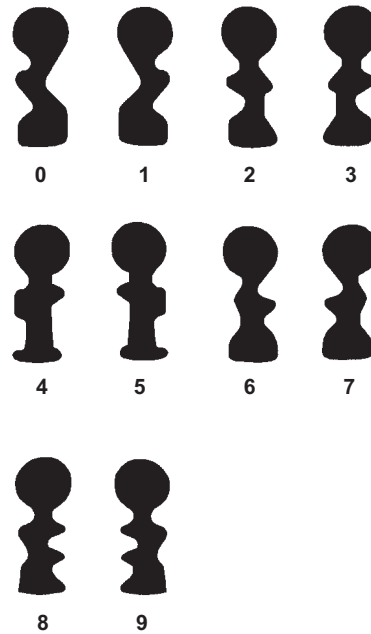
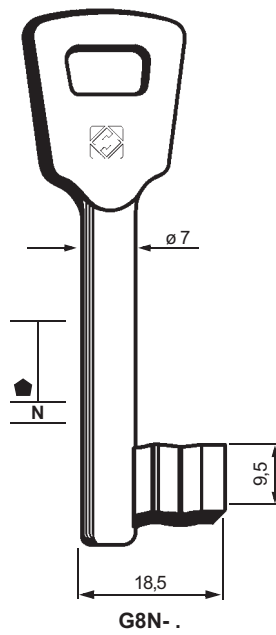

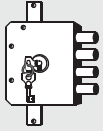

86

FOR/PER

BKS (D)

BODA (FIN)

FOR:

PER:

BKS

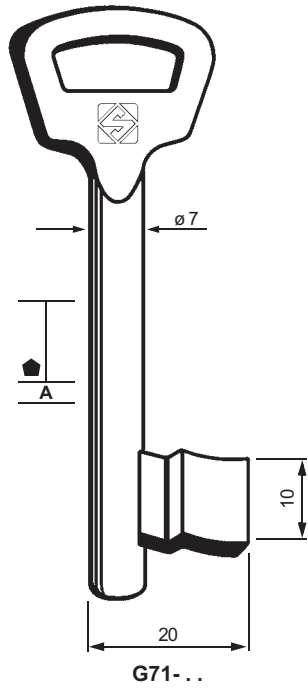

13 1/2



15 1/2



17 1/2



19 1/2



21 1/2



23 1/2



27 1/2



31 1/2

FOR:
PER:

BODA

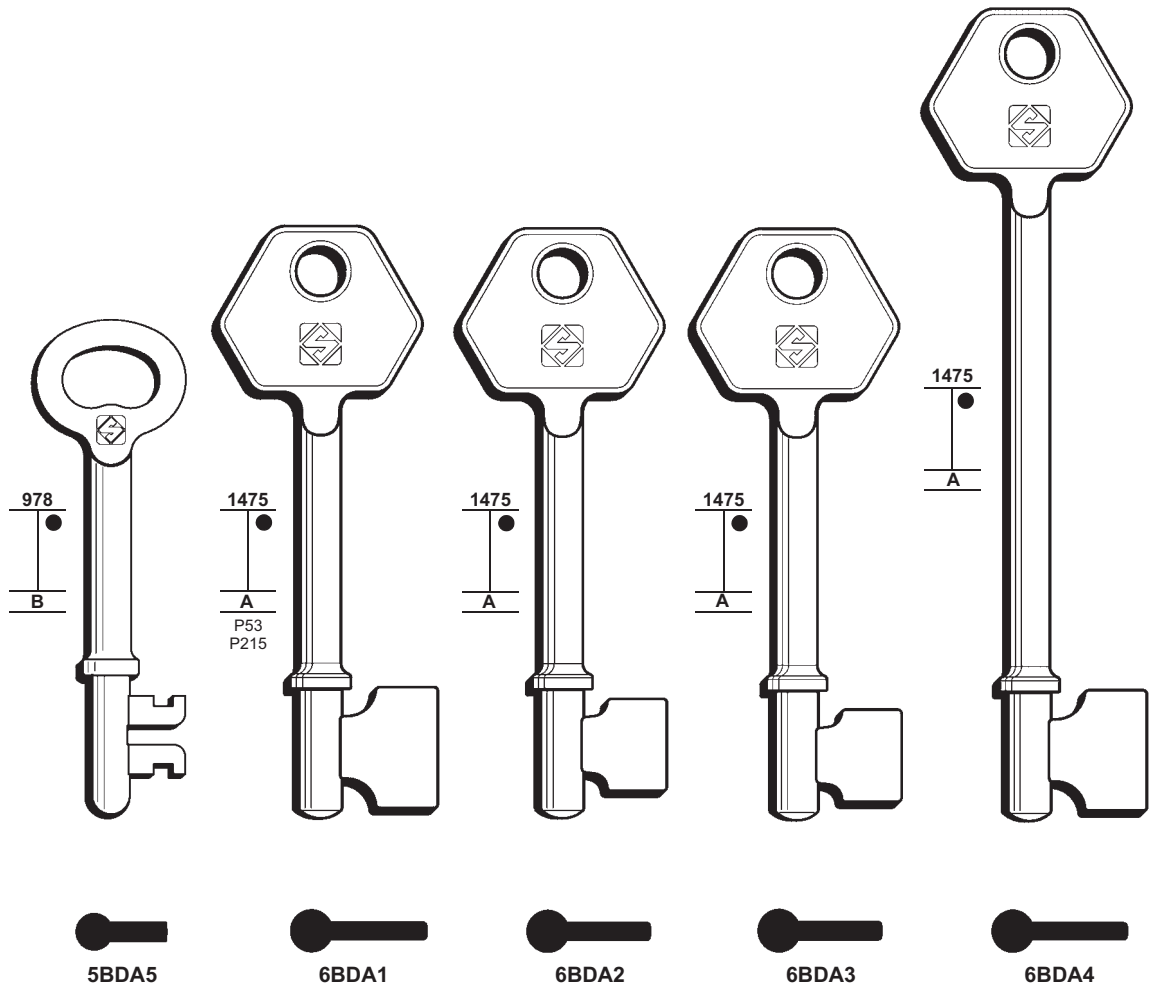

FOR:
PER:

BODE

BRANDTEK

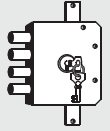

87

FOR/PER

BODE (D)
CAWI
WITTKOPP

BRANDTEK (S)

BRICARD (F)

CAWI (D)

BODE (87)

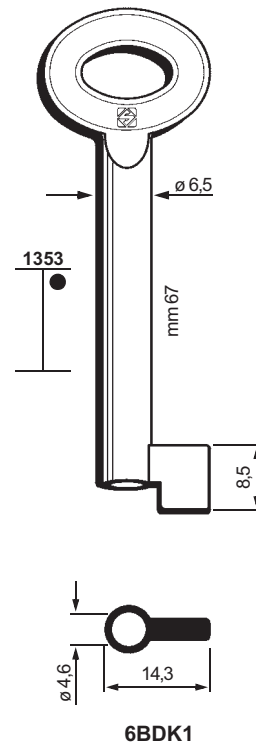
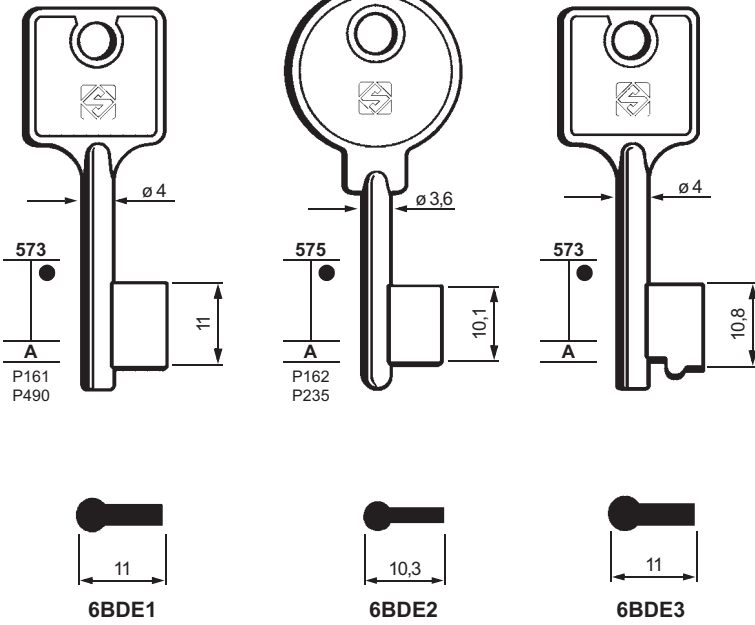

CAWI-WITTKOPP

FOR:
PER:

BRICARD

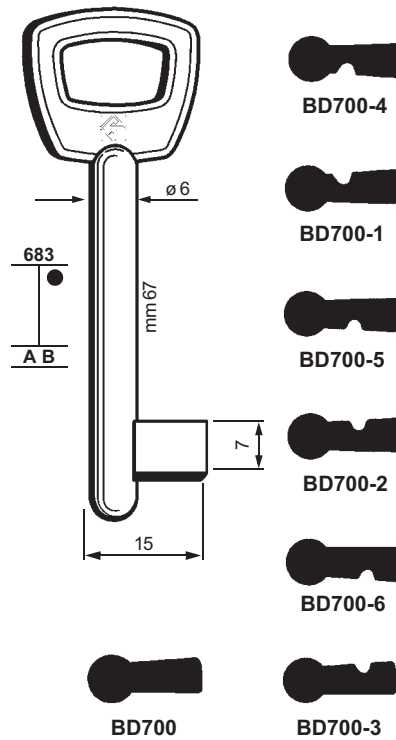
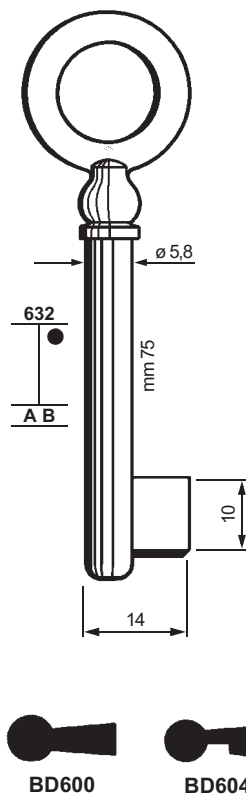
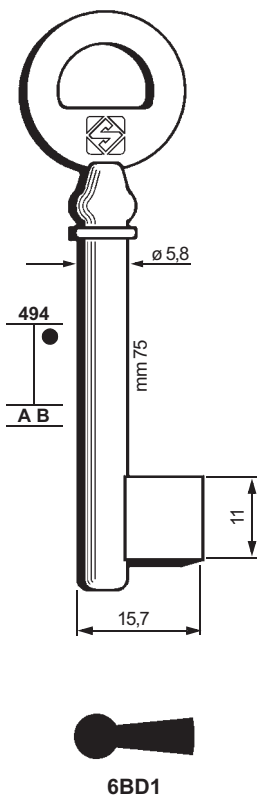

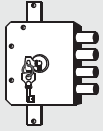

88

FOR/PER

CHUBB (GB)

CIS (I)

COUILLET (F)

CUIRASSEE (F)

FOR:

PER:

CHUBB

CIS

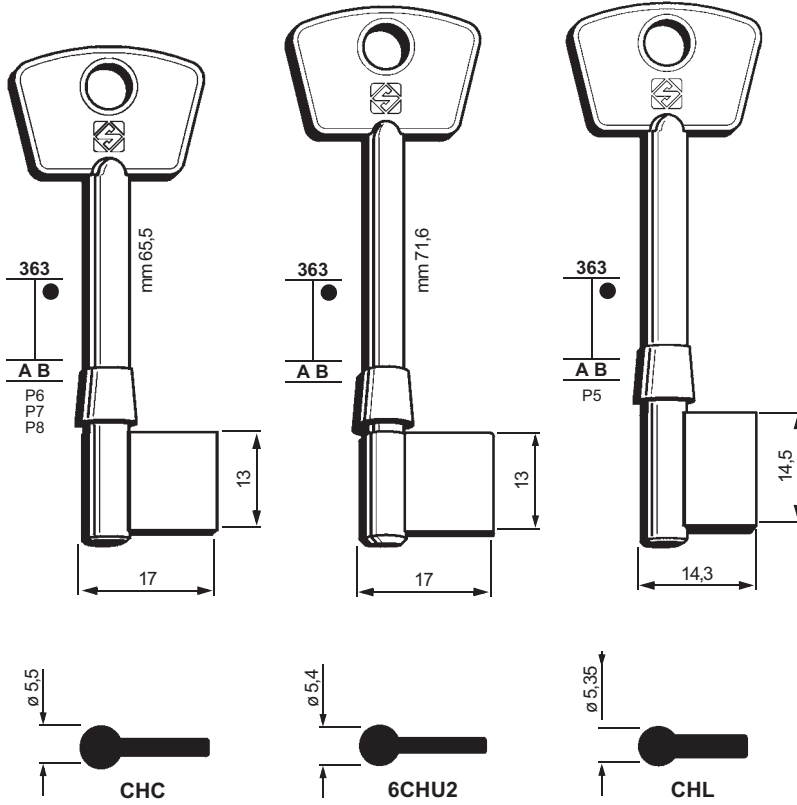

FOR:

PER:

COUILLET

CUIRASSEE

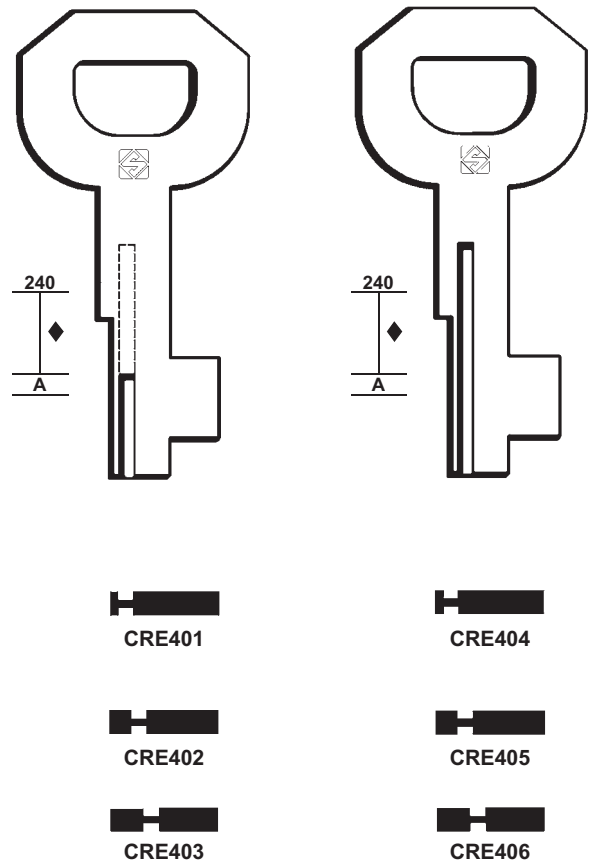
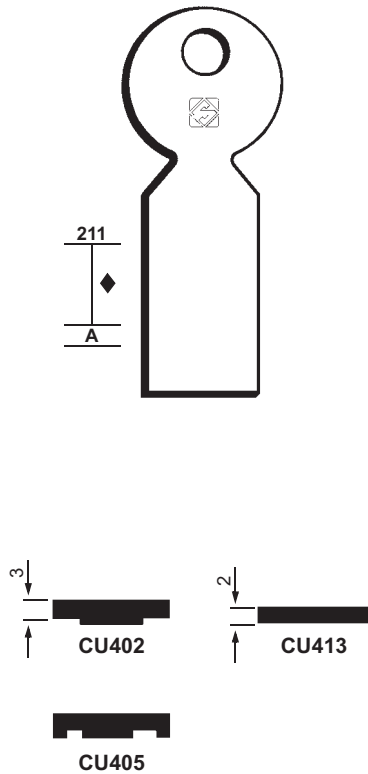

FOR: **DAD-DECAYEUX**

DEBEAURAIN

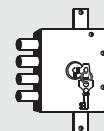

89

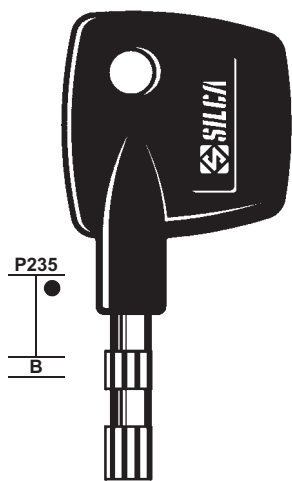

P235
B



5DD1P

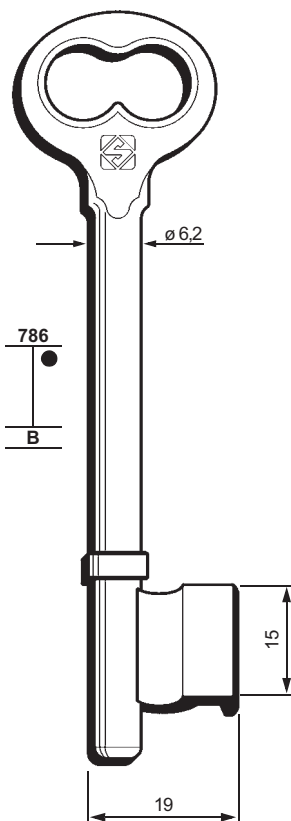

ND760LC-...



10 18 19



20 29 30

FOR/PER

DAD-DECAYEUX (F)

DEBEAURAIN (F)

FOR:
PER:

DEBEAURAIN

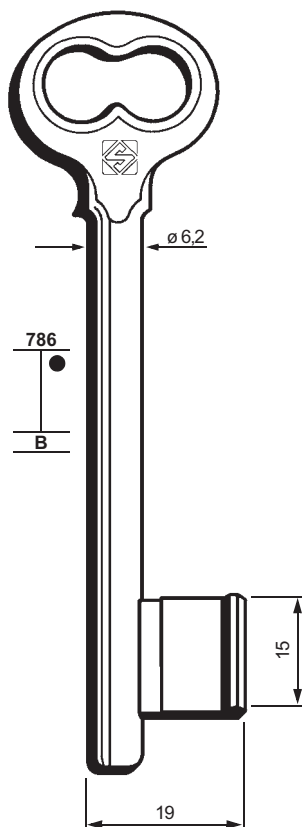

ND760L-...

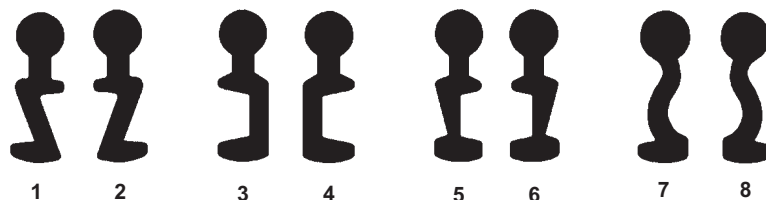

1 2 3 4 5 6 7 8

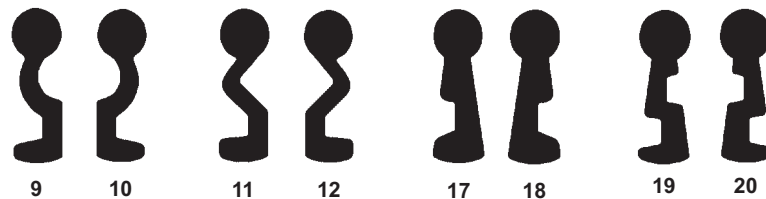

9 10 11 12 17 18 19 20

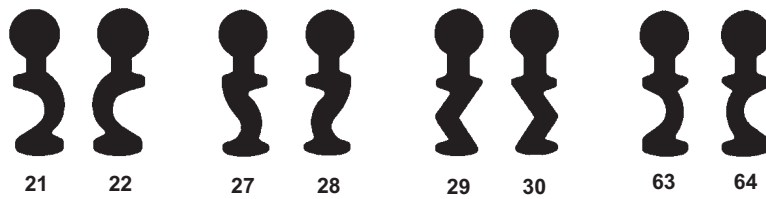

21 22 27 28 29 30 63 64

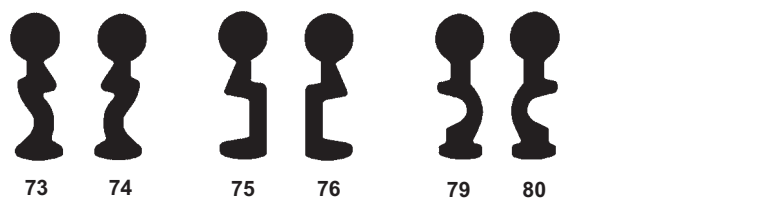

73 74 75 76 79 80

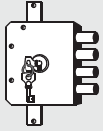

90

FOR/PER

DEBEAURAIN (F)

ELZETT (H)

EMERY (F)

ERA (GB)

FOR:
PER:

DEBEAURAIN

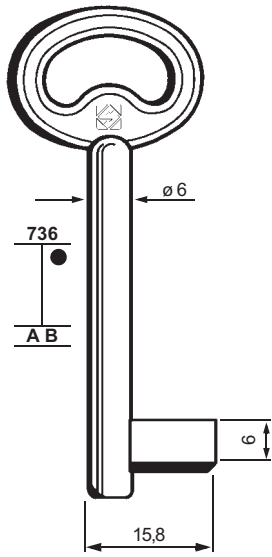

ND740L



ND740L-1



ND740L-4



ND740L-6



ND740L-8



ND740L-10



ND740L-5



ND740L-7



ND740L-9

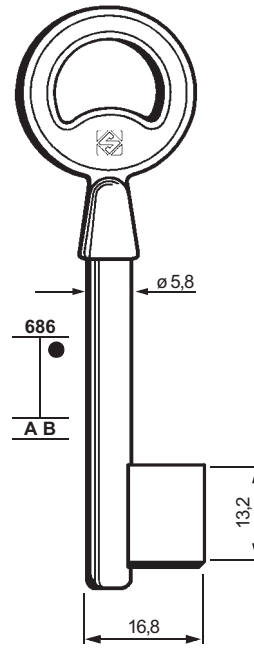

ND706L

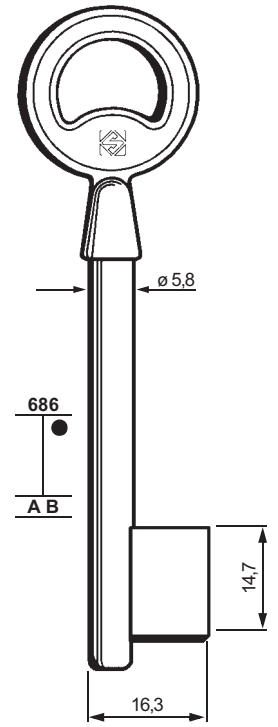

ND704L

FOR:
PER:

ELZETT

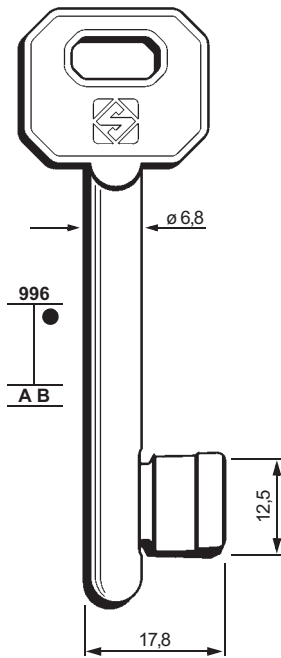

6EL2



6EL1

EMERY

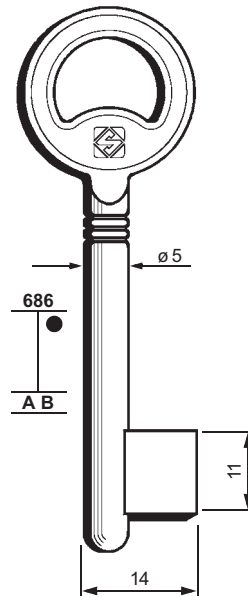

EY300

ERA

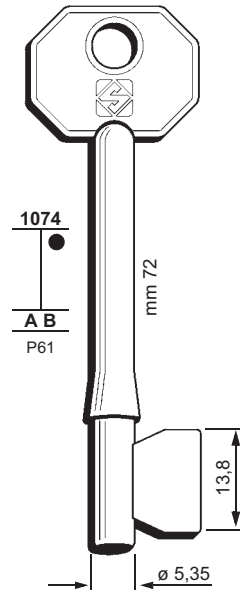

6ER1

FOR:
PER:

FICHET

FTH

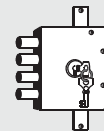
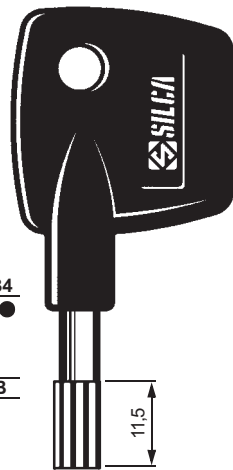
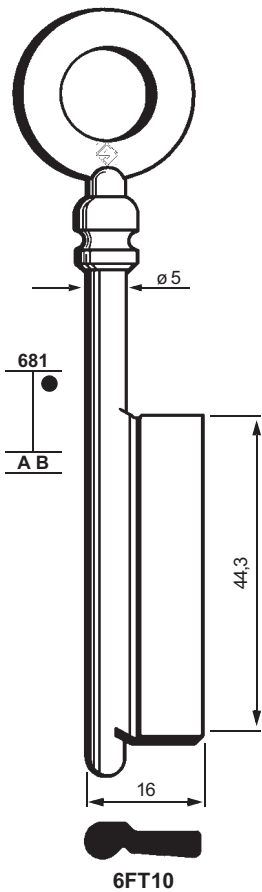
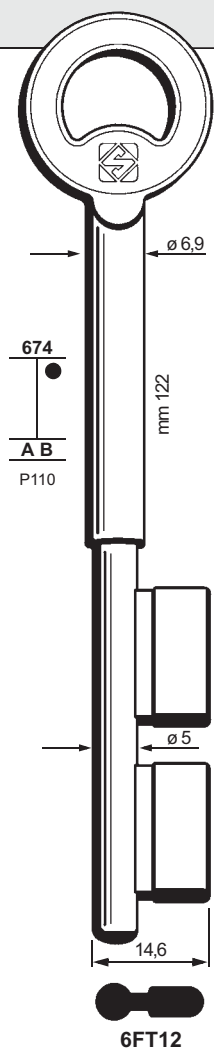

91

FOR/PER

FICHET (F)

FTH (F)

FOR:
PER:

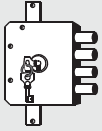

92

FOR/PER
GEGE (A)

FOR:
PER:

GEGE

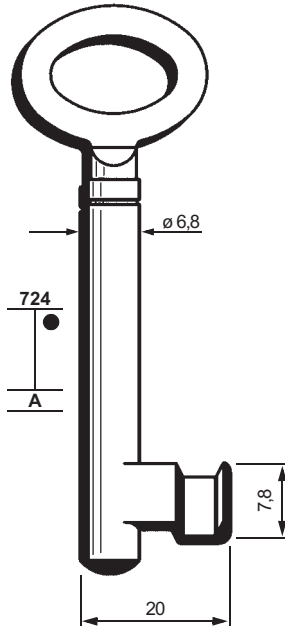

FOR:
PER:

GLITTENBERG

GOLLOT

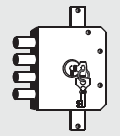

93

FOR/PER

GLITTENBERG (D)

GOLLOT (F)

GPZ (RUS)

HELASON (A)

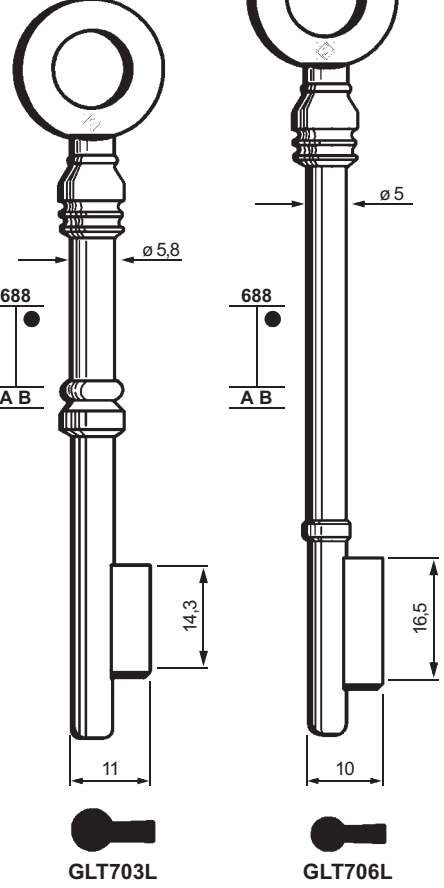
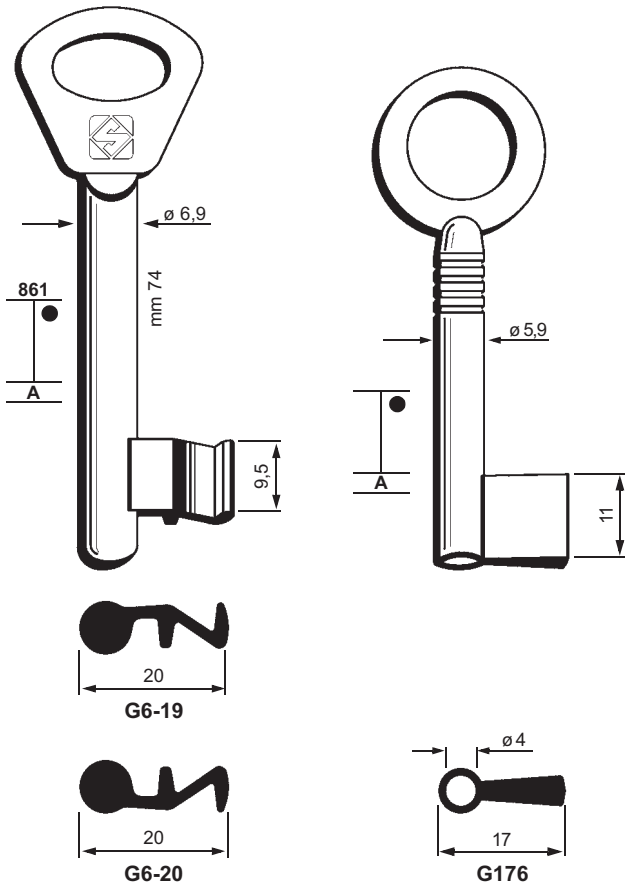

FOR:
PER:

GOLLOT

GPZ

HELASON

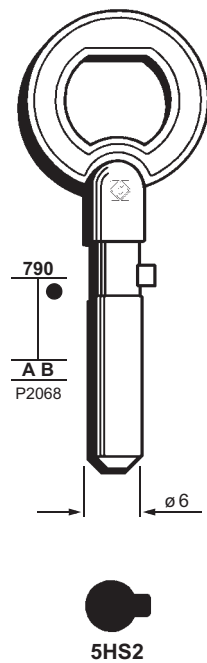
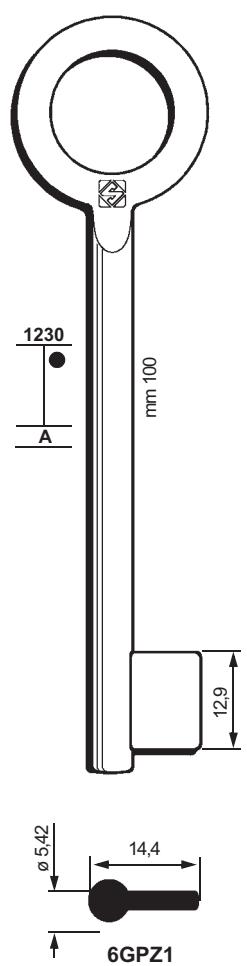
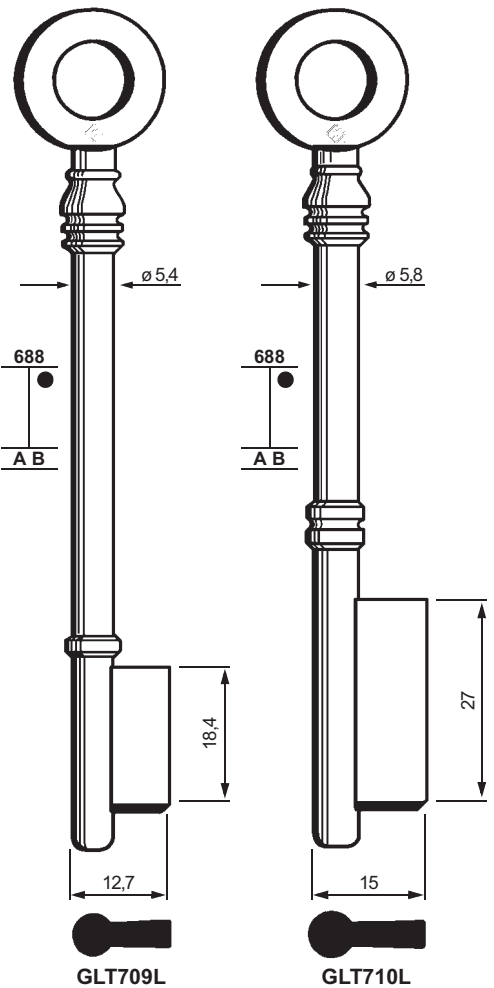

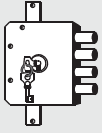

94

FOR/PER
HOBES (CZ)

FOR:
PER:

HOBES

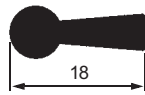
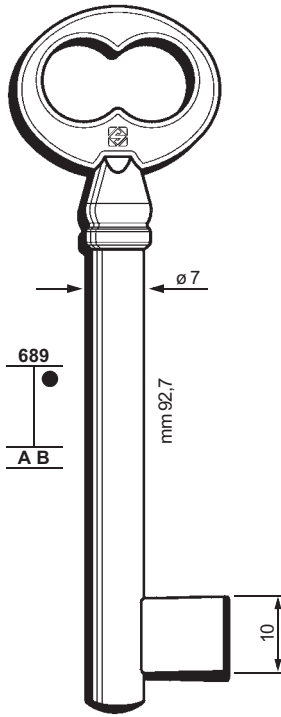

6HOB1

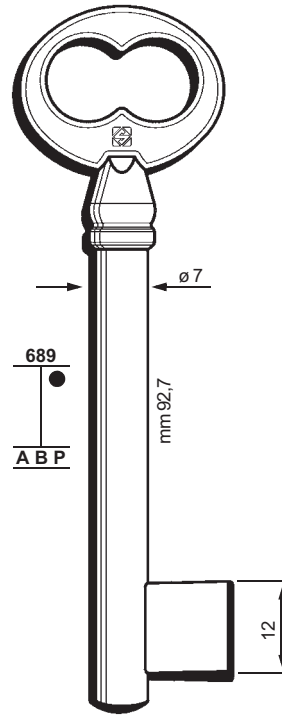

6HOB2

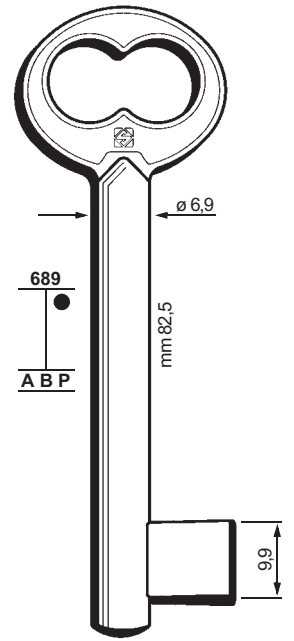

6HOB4

FOR:
PER:

HOBES

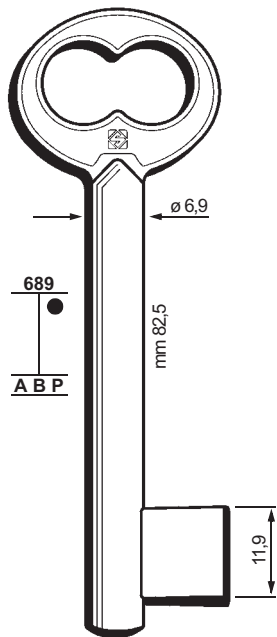

6HOB3

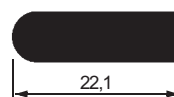
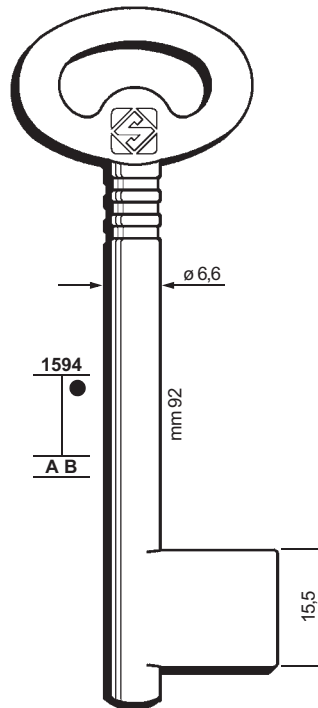

6HOB5

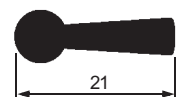
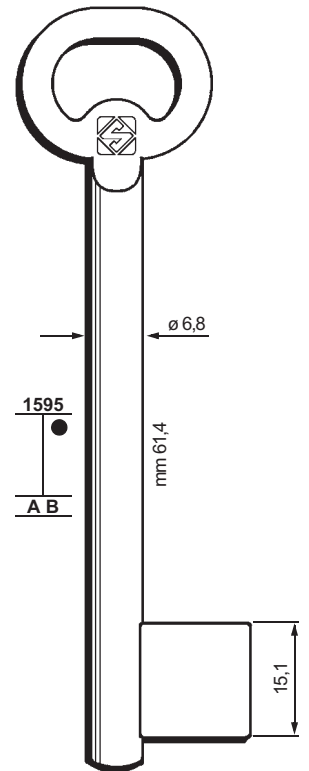

6HOB9

FOR:
PER:

HOBES

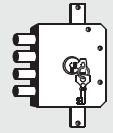

95

FOR/PER

HOBES (CZ)

JPM (F)

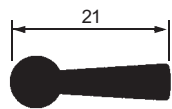
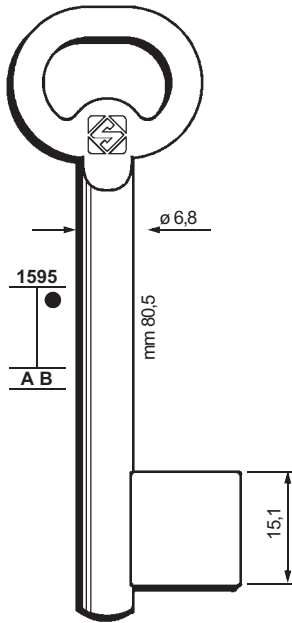

6HOB7

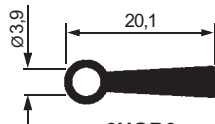
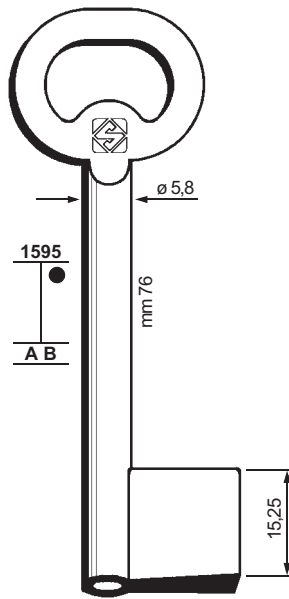

6HOB6

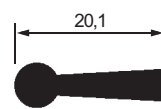
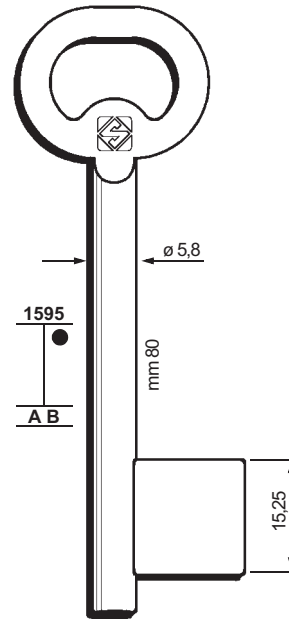

6HOB8



FOR:
PER:

JPM

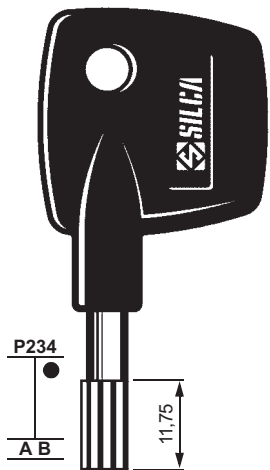

5JM1P



5JM2P

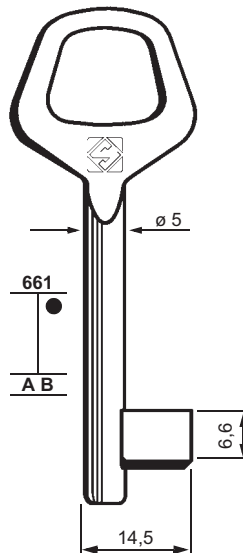

6JM1



6JM1-1



6JM1-2



6JM1-6



6JM1-7



6JM1-8



6JM1-9



6JM1-10



6JM1-11



6JM1-12

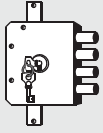

96

FOR/PER

JPM (F)

KROMA (D)

OSTERTAG (101)

FOR:
PER:

JPM

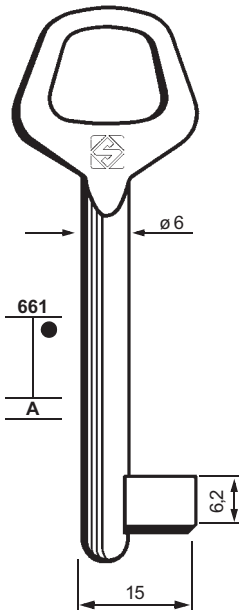

6JM00L

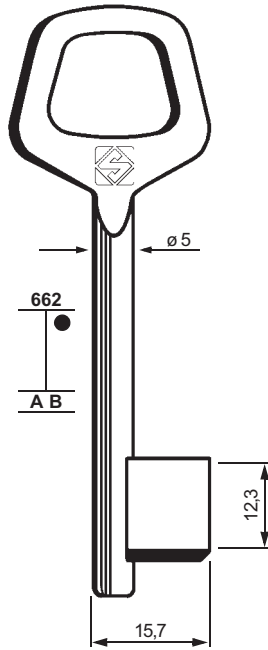

6JM2

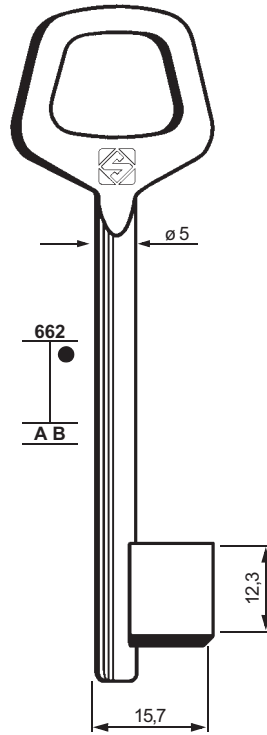

6JM3

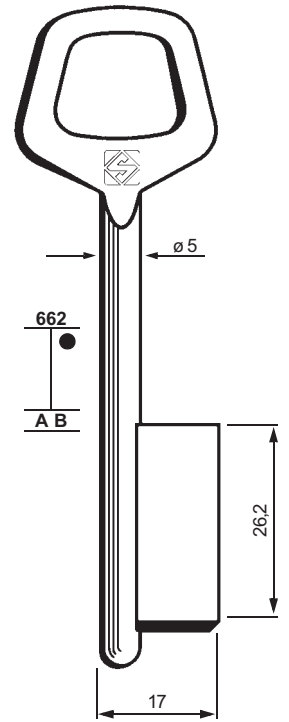

6JM4

FOR:
PER:

JPM

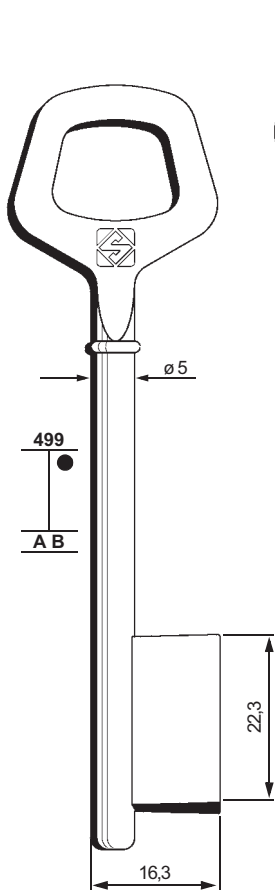

6JM5

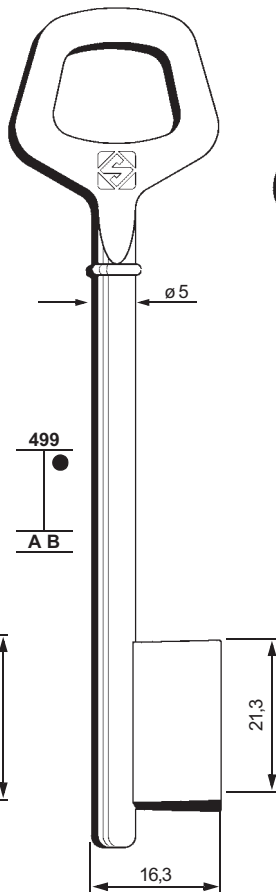

6JM6

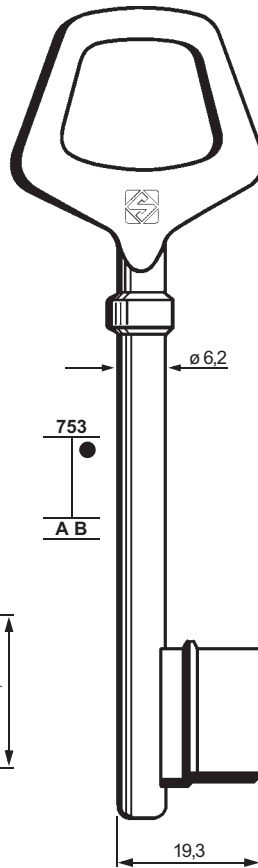

JM710L- . .

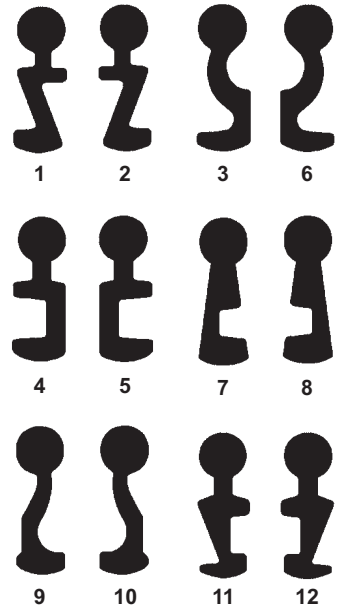

FOR:
PER: **KROMNI**

LAPERCHE

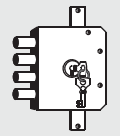

97

FOR/PER
KROMNI (WAN)
UNION
LAPERCHE (F)

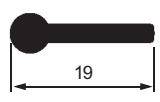
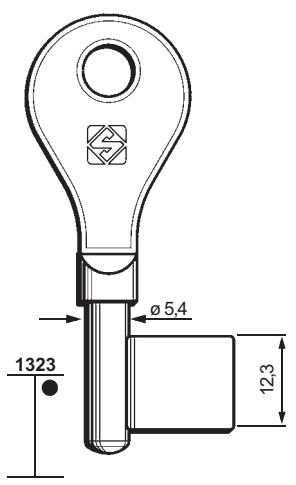

6KRN1
UNION

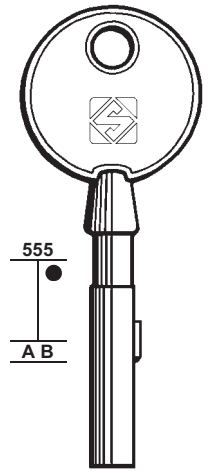

5LH1

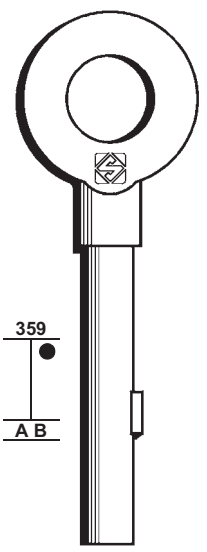

5LH3

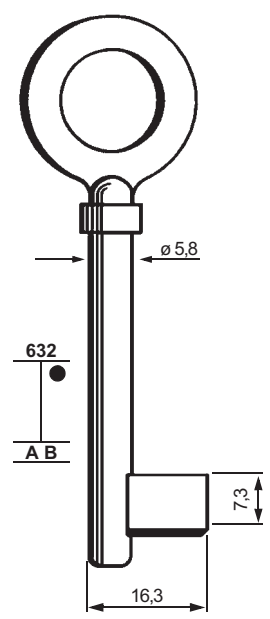

LH700

FOR:
PER: **LAPERCHE**

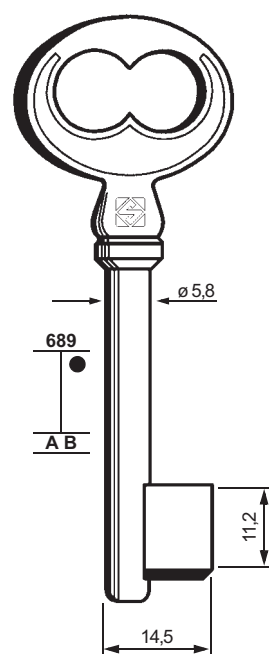

LH701

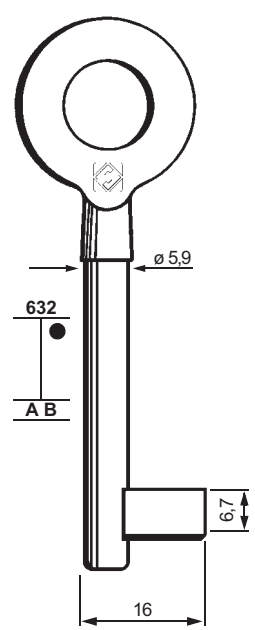

LH710L



LH710L-3



LH710L-4



LH710L-5



LH710L-6



LH710L-9



LH710L-10

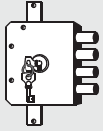

98

FOR/PER

LAPP-FINZE (A)

LAUDON (GB)

LINCE (E)

LOWE & FLETCHER (GB)

MAFOR (F)

FOR:
PER:

LAPP-FINZE

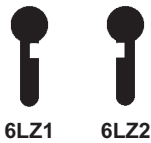
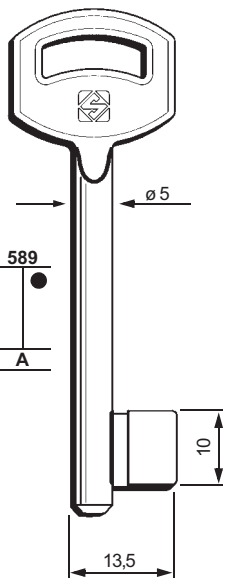

6LZ1

6LZ2



6LZ3

6LZ4

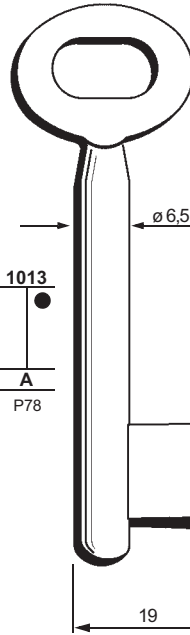

6LZ5-1



6LZ5-2



6LZ5-3



6LZ5-4



6LZ5-5



6LZ5



6LZ5-6

LAUDON

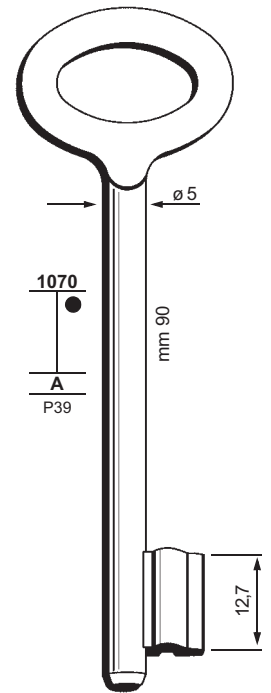

6LDN1

FOR:
PER:

LINCE

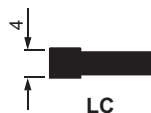
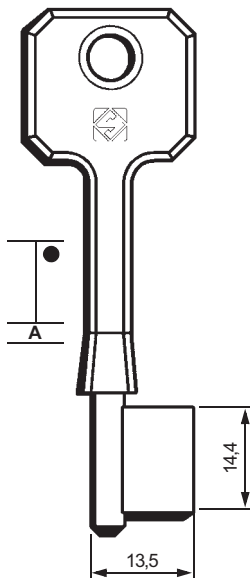

LC

LOWE & FLETCHER

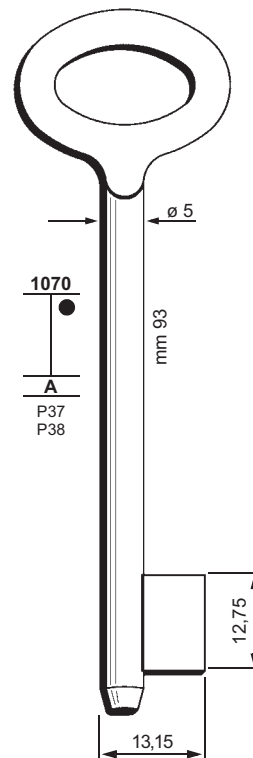

6LW2

MAFOR

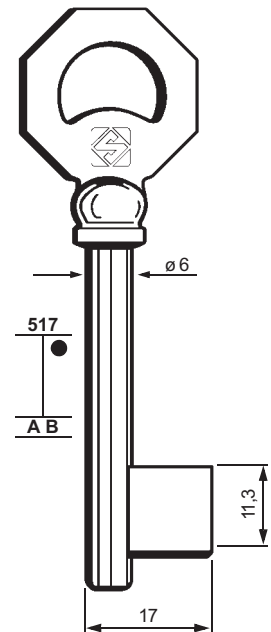

6MF1

FOR: **MARSTON**

MOBELLA

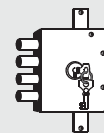

99

FOR/PER

MARSTON (GB)

MOBELLA (S)

MUEL (F)

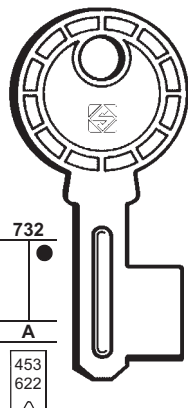
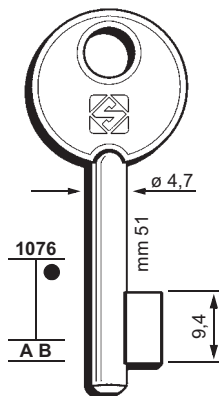

MBS300

- (SER11) 22001-22750
- (SER12) 17501-18250
- (SER13) 16001-16750
- (SER14) 18251-19000
- (SER15) 16751-17500
- (SER21) 11501-12250
- (SER22) 24251-25000
- (SER23) 10751-11500
- (SER24) 12251-13000
- (SER25) 10001-10750
- 1-2-3-4-5
- 1-2-3-4-5

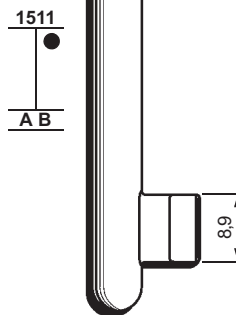
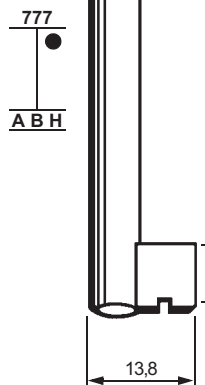

MBS301

- (SER11) 40751-41500
- (SER12) 36251-37000
- (SER13) 34751-35500
- (SER14) 37001-37750
- (SER15) 35501-36250
- (SER21) 30251-31000
- (SER22) 43001-43750
- (SER23) 29501-30250
- (SER24) 31001-31750
- (SER25) 28751-29500
- 1-2-3-4-5
- 1-2-3-4-5

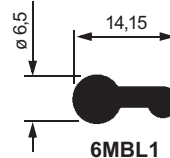
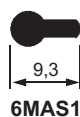

FOR:
PER:

MUEL

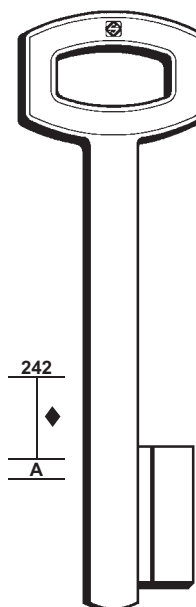
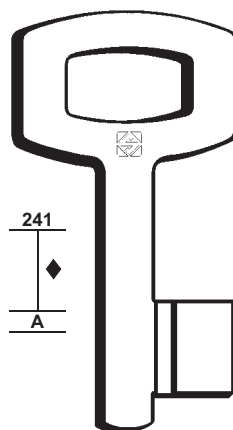
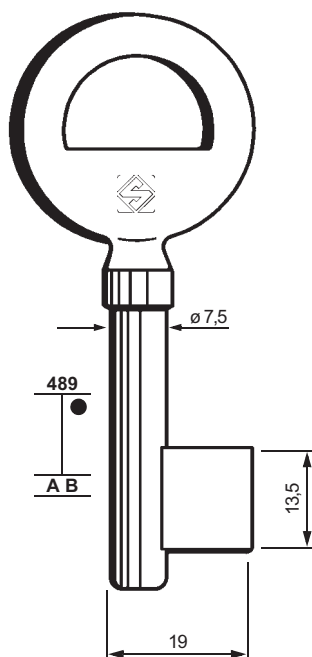

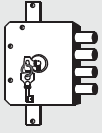

100

FOR/PER

NEMEF (NL)
V.S.B.

FOR:
PER:

NEMEF

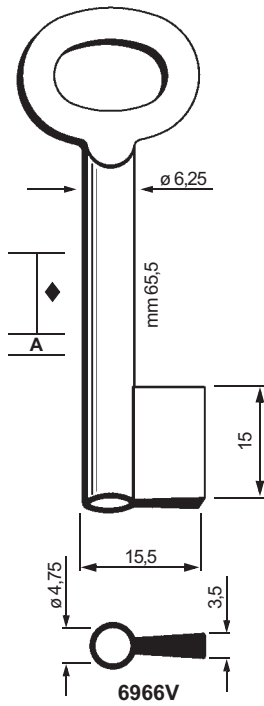

V.S.B.

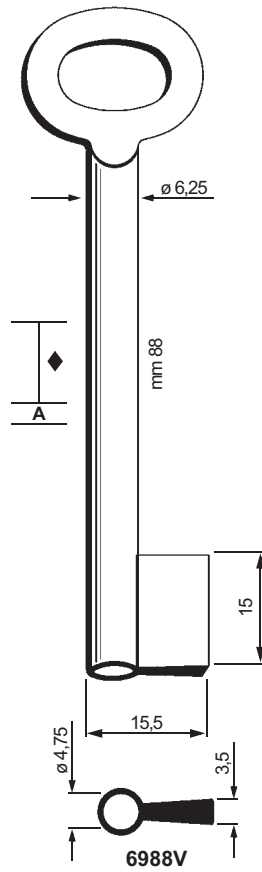

6988V

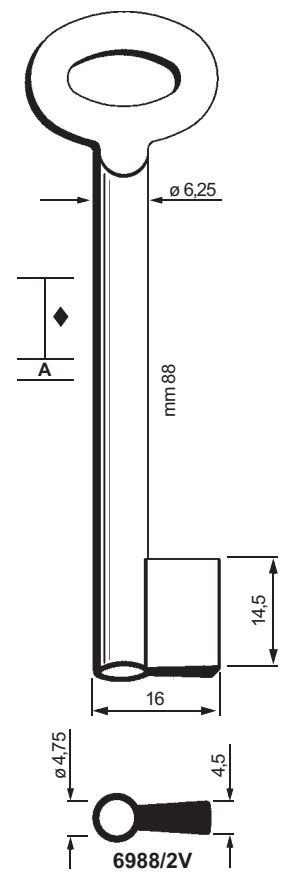

V.S.B.

FOR:
PER:

NEMEF

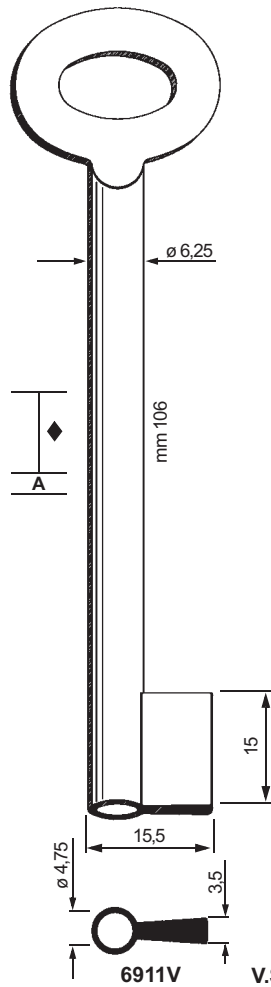

6911V

V.S.B.

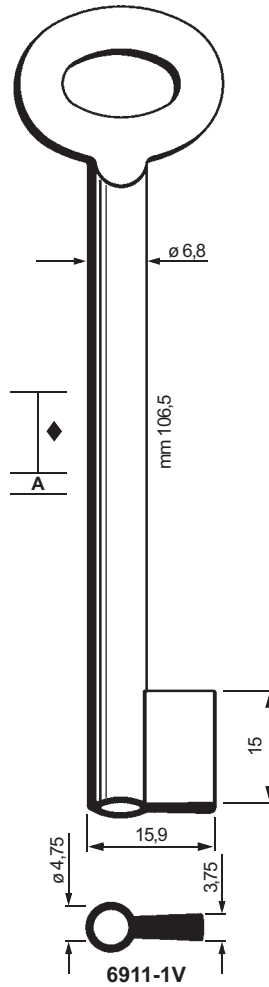

6911-1V

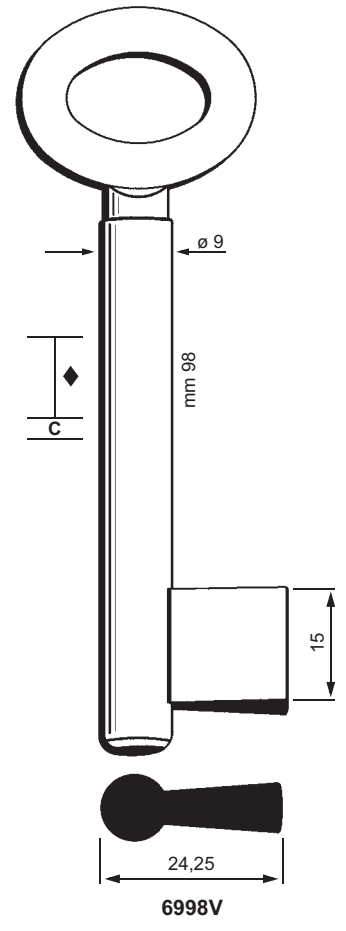

6998V

FOR:
PER:

NEMEF

ORENGO

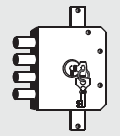

101

FOR/PER

NEMEF (NL)

ORENGO (E)

OSTERTAG (D)
KROMA

PANZER (RA)

PATENT (I)

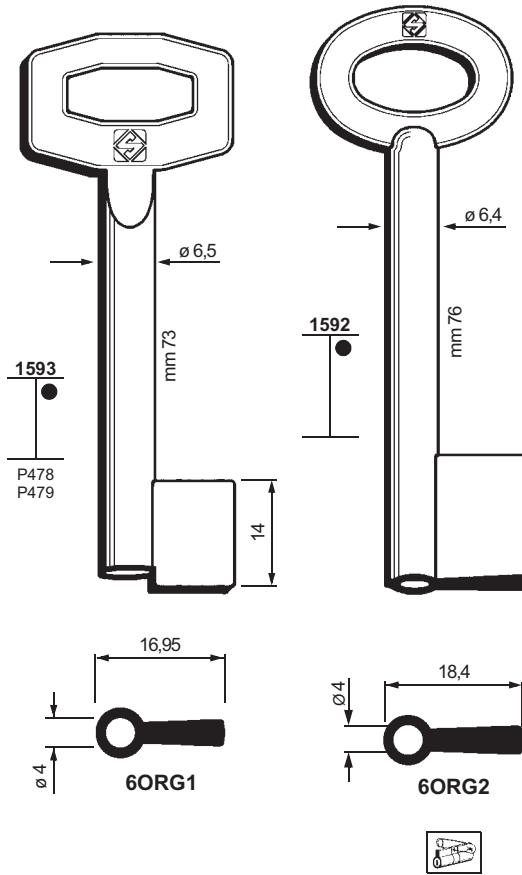
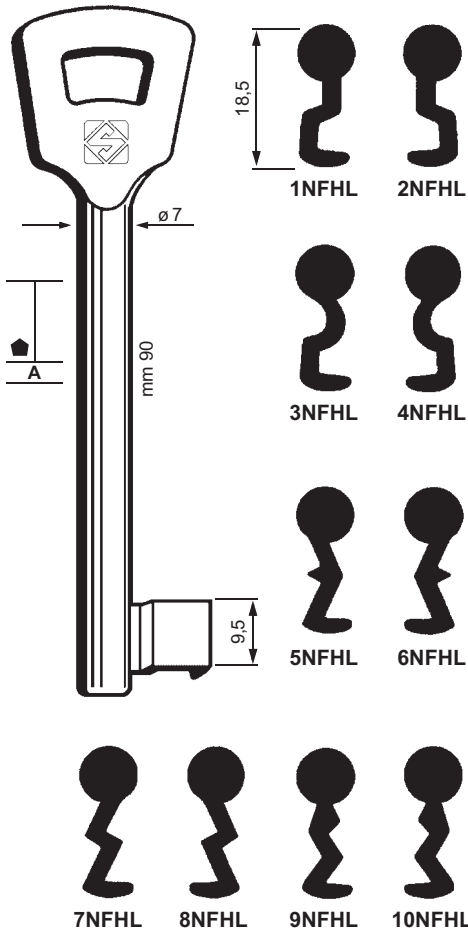

FOR:
PER:

OSTERTAG

PATENT

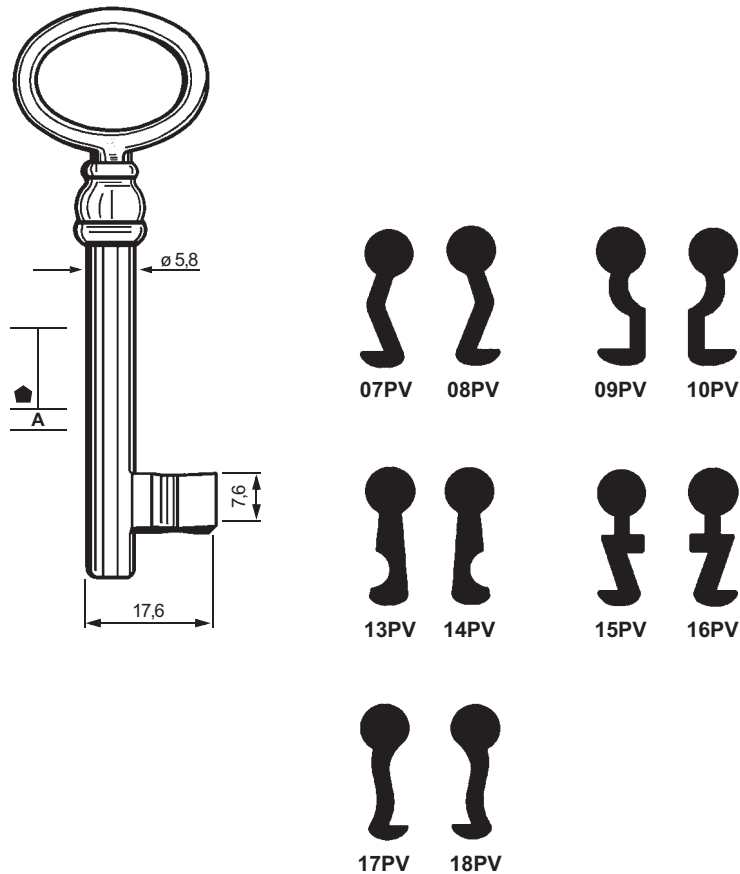
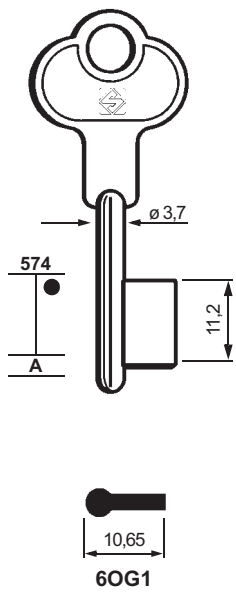

KROMA

OLD TYPE / TIPO VECCHIO

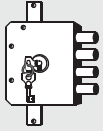

102

FOR/PER
 PICARDIE (F)
 POLLUX (F)
 PROGRES
 FONTAINE (F)

FOR:
PER:

PICARDIE

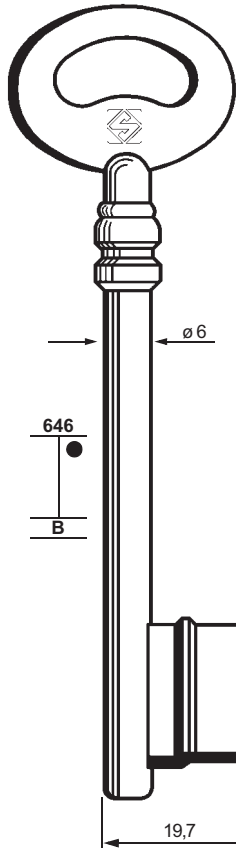

PIC710L- . .



FOR:
PER:

POLLUX

PROGRES FONTAINE

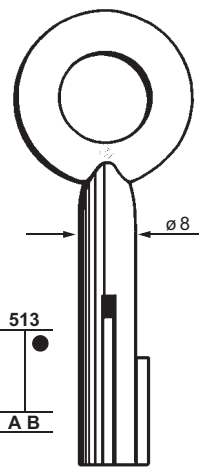
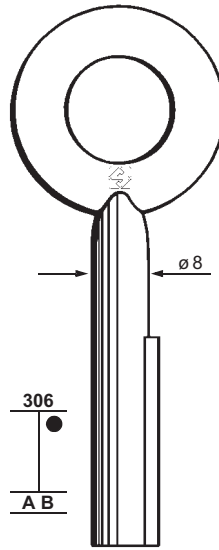
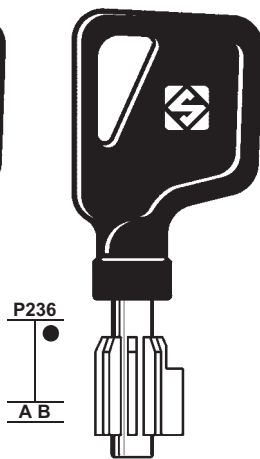
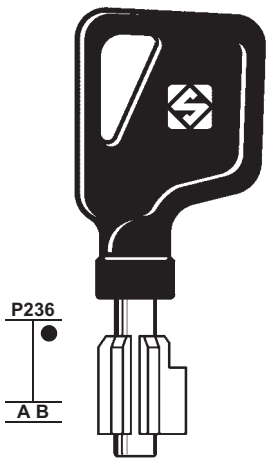

FOR:
PER: **REFORM**

RUBIS

STUV

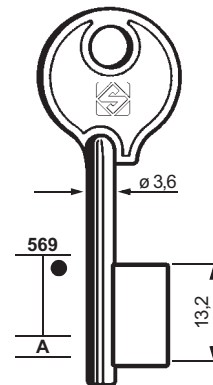
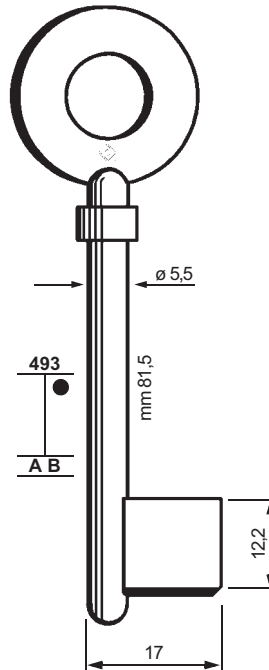
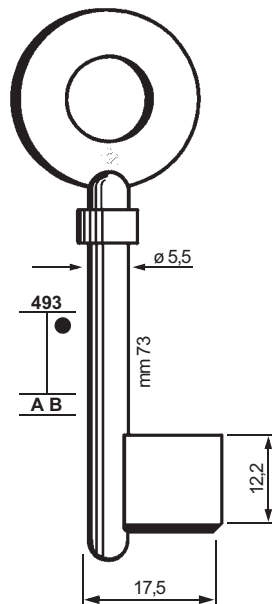
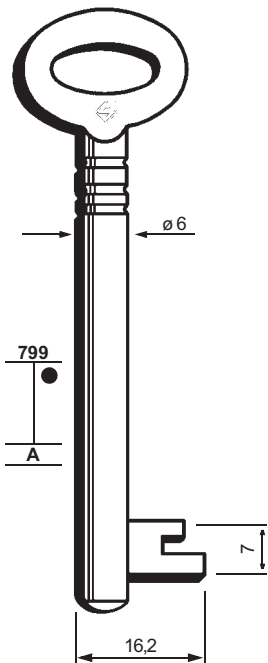

RF700



RS602



RS603



RS616



RS617



RS604



RS601



RS615

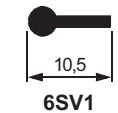

6SV1

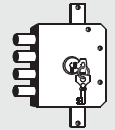

103

FOR/PER

REFORM (A)

RUBIS (F)

RUSSIA (RUS)

SELECT (F)

STUV (D)

FOR:
PER: **RUSSIA**

SELECT

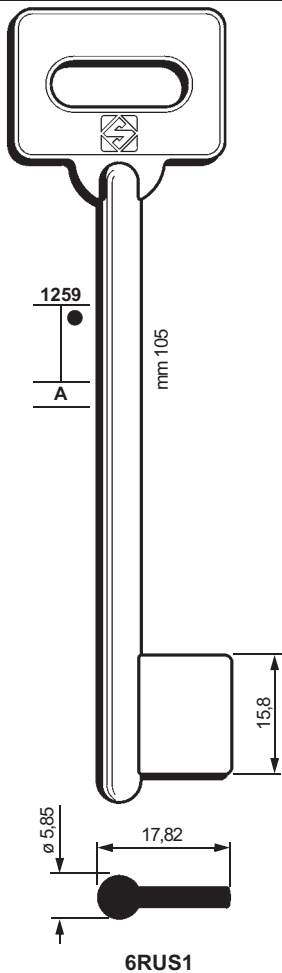

6RUS1

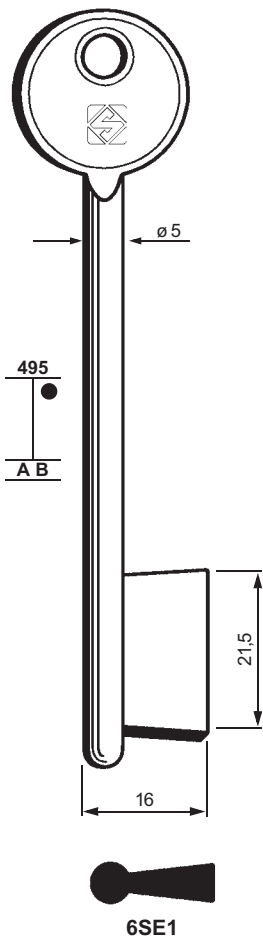

6SE1

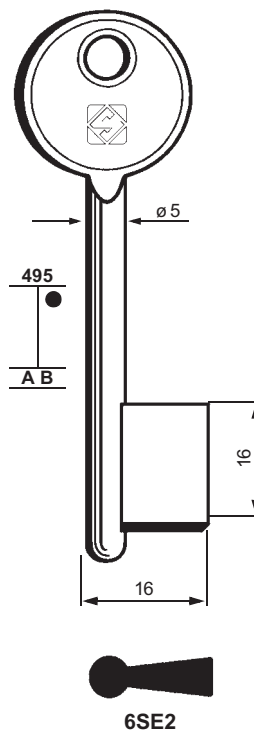

6SE2

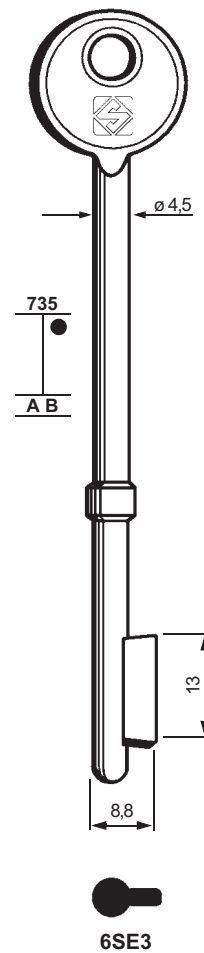

6SE3

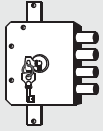

104

FOR/PER

SPERRZEUGE (D)

FOR:
PER:

SPERRZEUGE

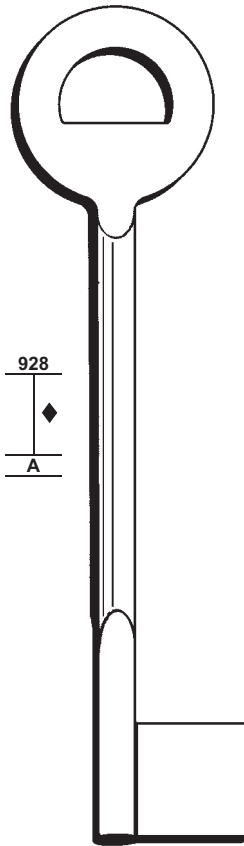

9911S



9911S-K1

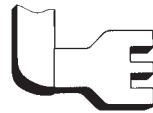

9911S-K2



9911S-K3

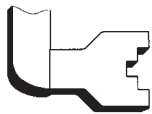

9911S-K4

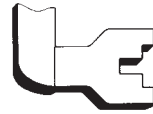

9911S-K5

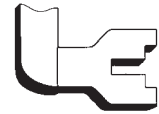

9911S-K6

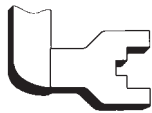

9911S-K7

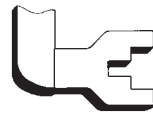

9911S-K8

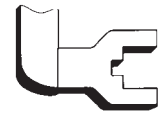

9911S-K9



9911S-K10



9911S-K11



9911S-K12

FOR:
PER:

SPERRZEUGE

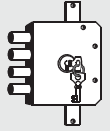

105

FOR/PER

SPERRZEUGE (D)

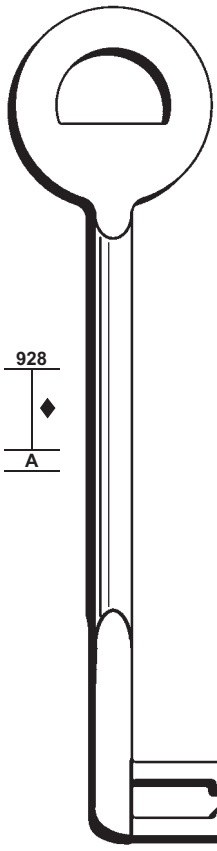

928
A

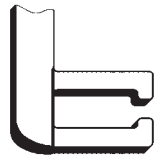

9911S-01

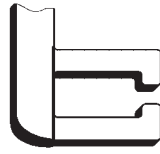

9911S-02

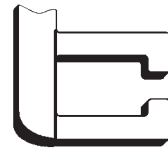

9911S-03

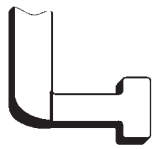

9911S-04

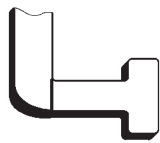

9911S-05

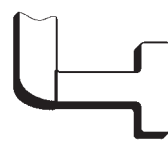

9911S-06

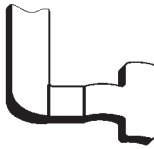

9911S-07

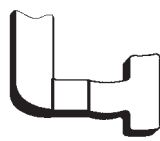

9911S-08

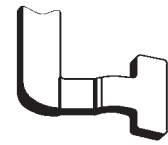

9911S-09

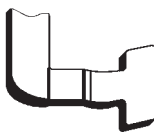

9911S-10



9911S-11



9911S-12

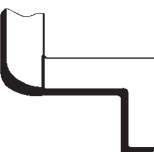

9911S-13



9911S-14

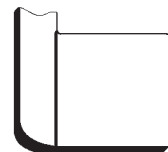

9911S-15



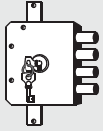

106

FOR/PER

TRIOVING (N)

UNION (GB)

+ KROMNI (97)

FOR: PER: TRIOVING

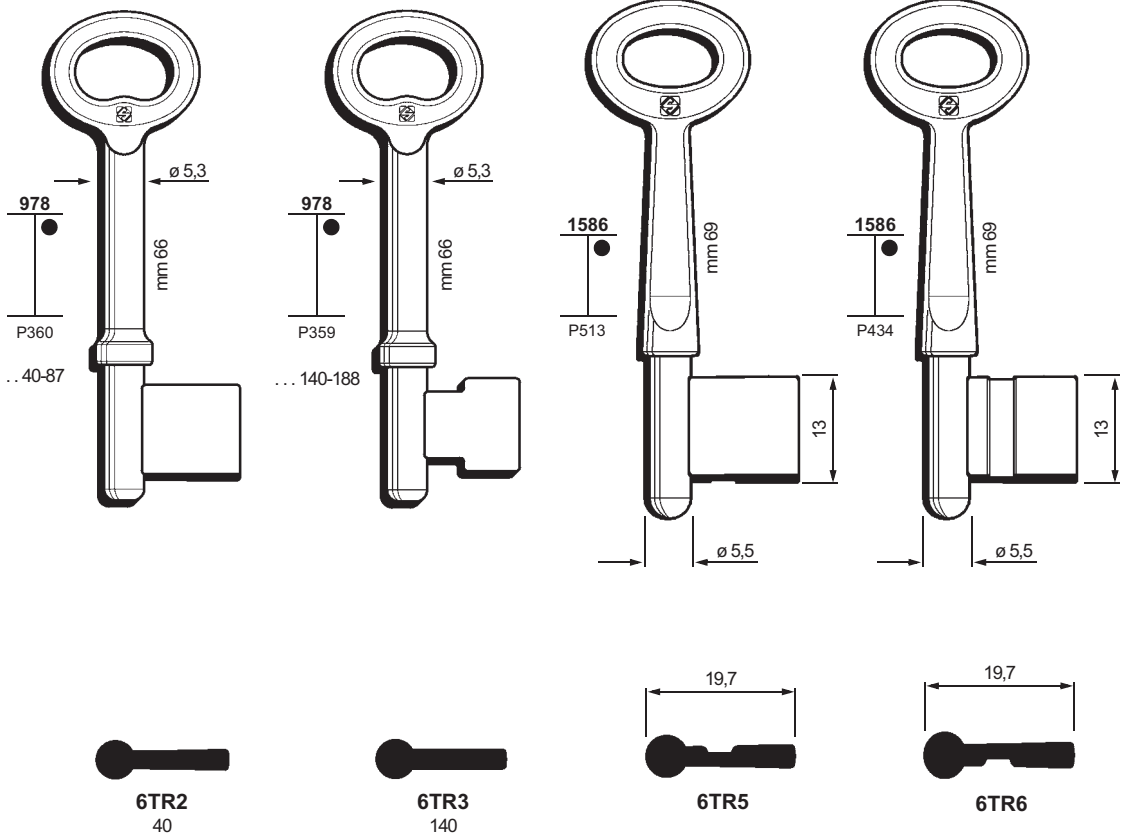

FOR: PER: TRIOVING

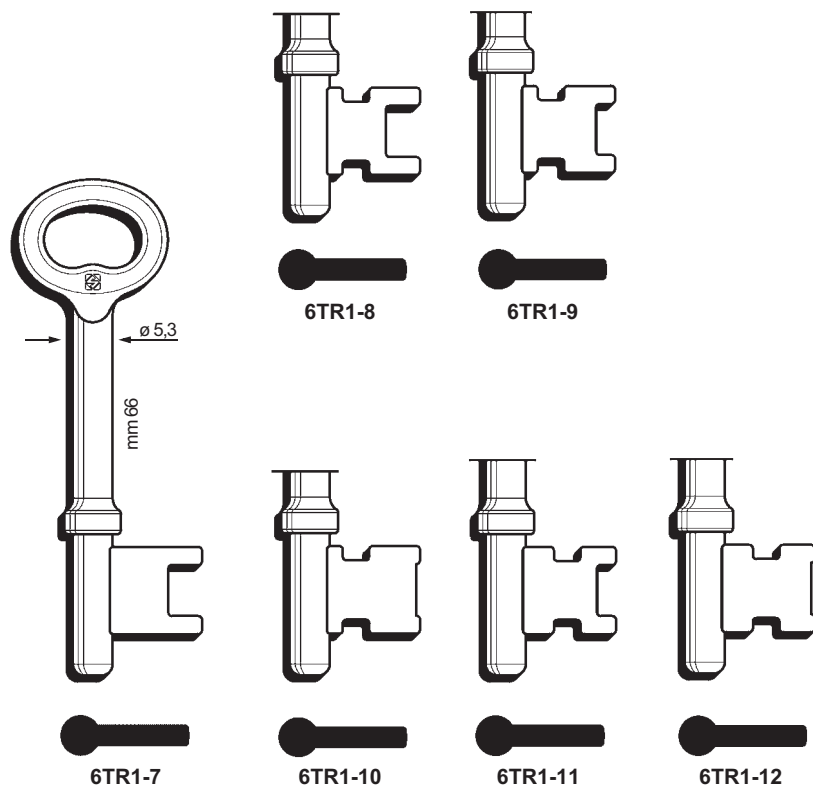

UNION

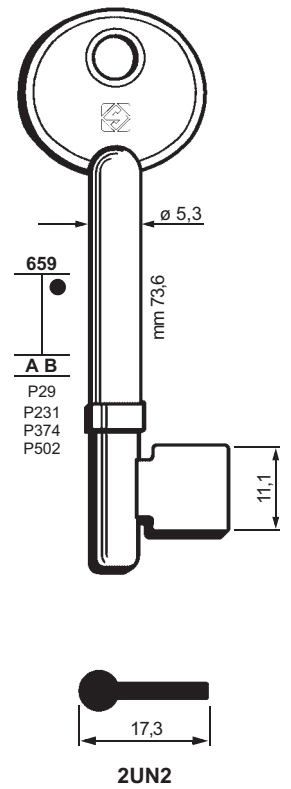

FOR:
PER:

UNION

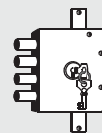

107

FOR/PER

UNION (GB)

+ KROMNI (97)

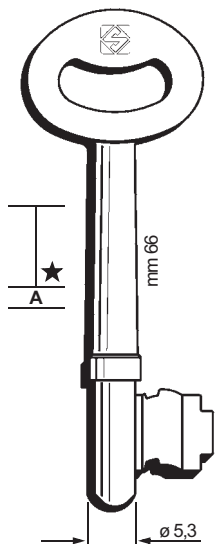

M26H



M32H



M14H



M20H

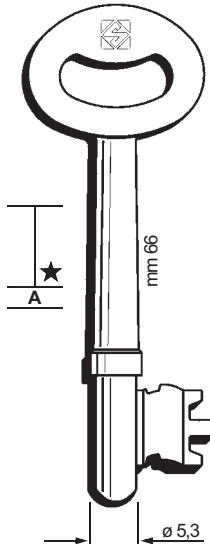

M25H



M31H



M13H

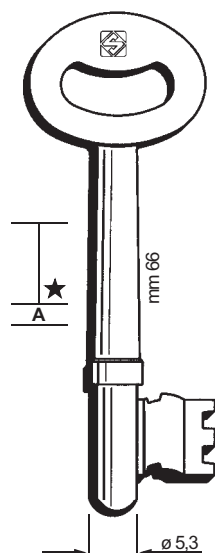

M21H



M27H



M9H



M15H



M37H



M33H

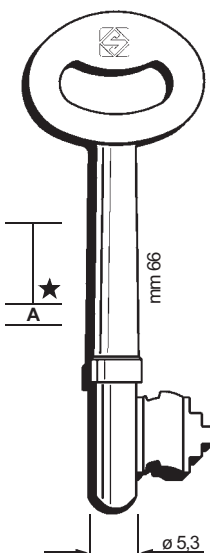

M22H



M28H



M10H



M16H



M38H



M34H

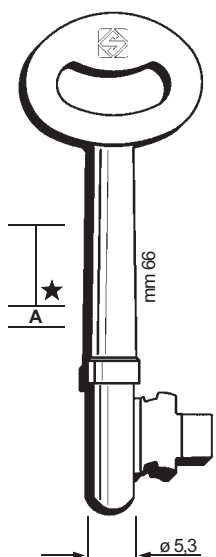

M23H



M29H



M39H



M35H

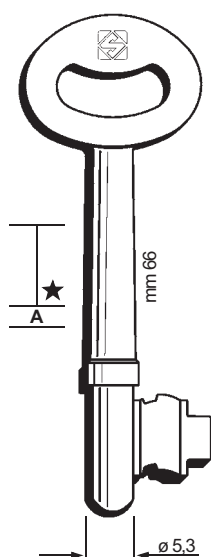

M24H



M30H



M12H



M18H



M40H



M36H

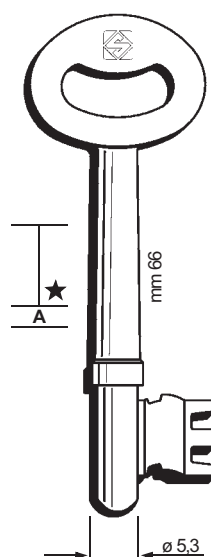

M17H



M11H

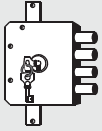

108

FOR/PER
VACHETTE (F)

FOR:
PER:

VACHETTE

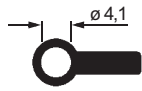
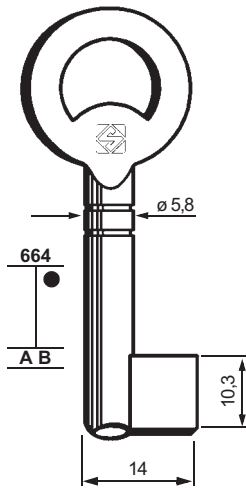

VAC304

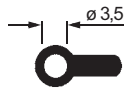
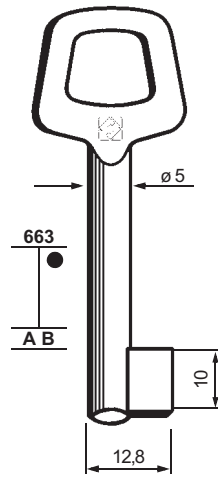

VAC303

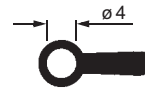
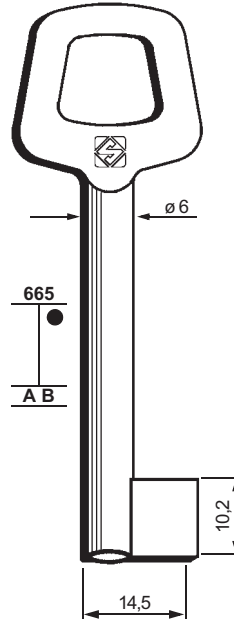

VAC305

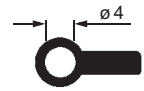
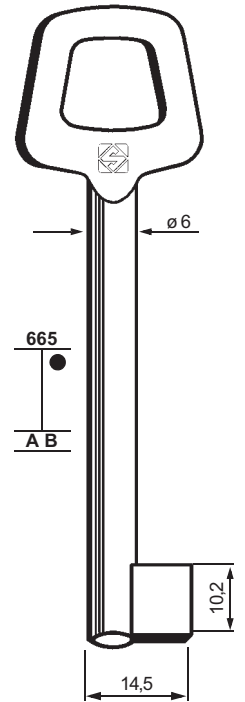

VAC306

FOR:
PER:

VACHETTE

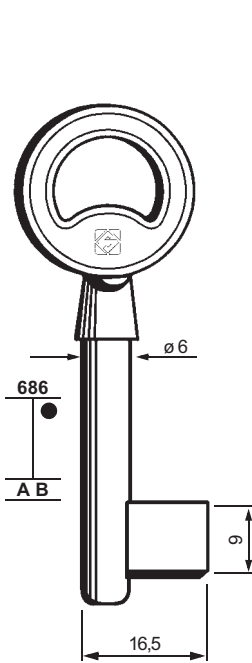

VAC301

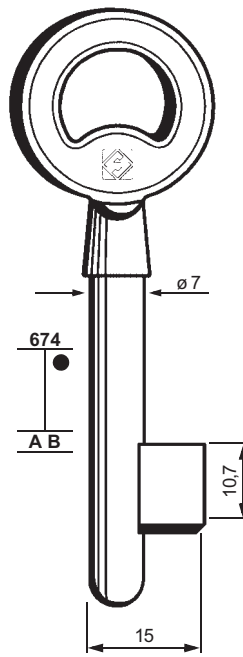

VAC302

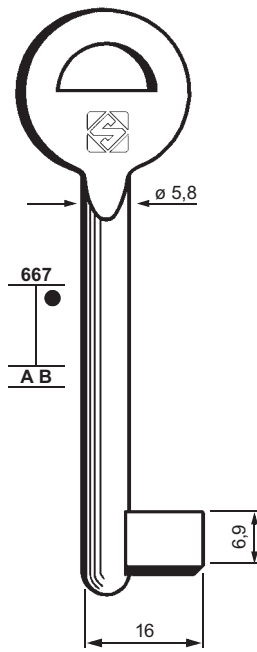

6VAC1



6VAC1-1



6VAC1-2



6VAC1-6

FOR:
PER:

VIGIE PICARD

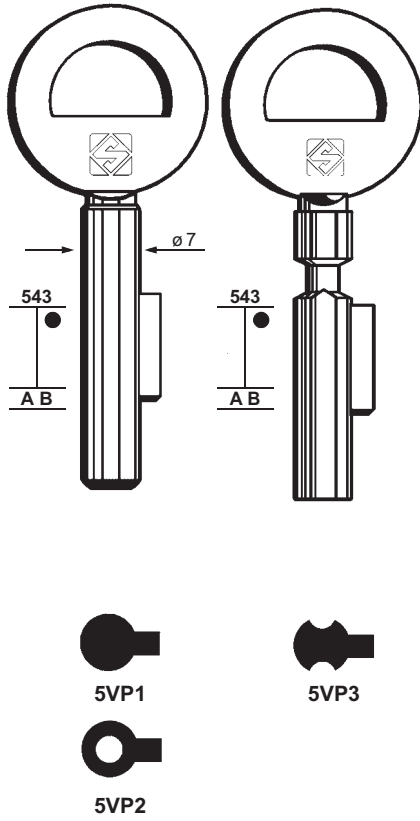

WG

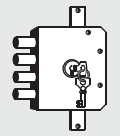
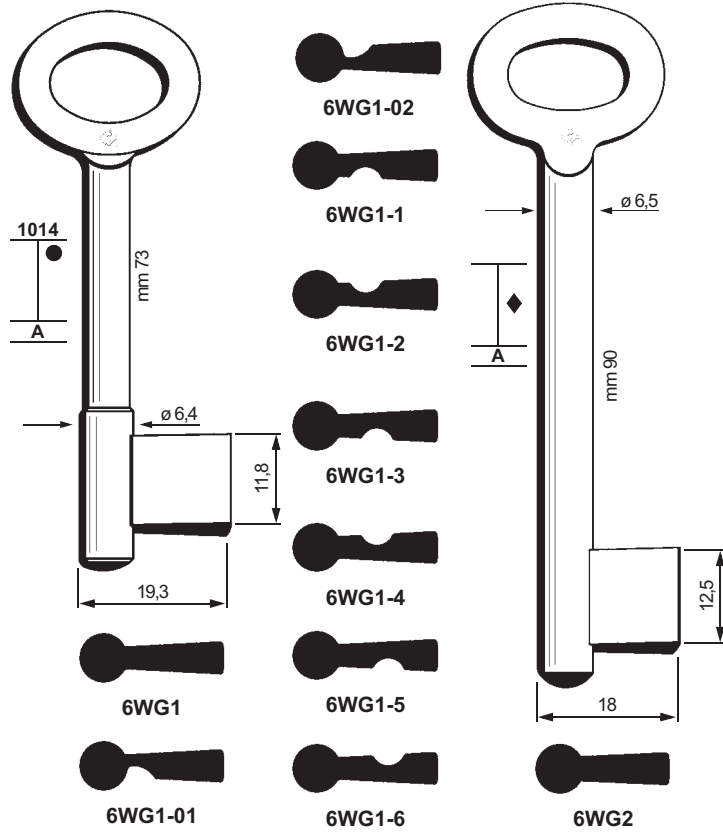

109

FOR/PER

VIGIE PICARD (F)

V.S.B. (NL)
NEMEF (100-100)

WG (A)

WITTKOPP (D)
BODE (87)

YALE (GB)

ZORATTO (I)

FOR:
PER:

YALE

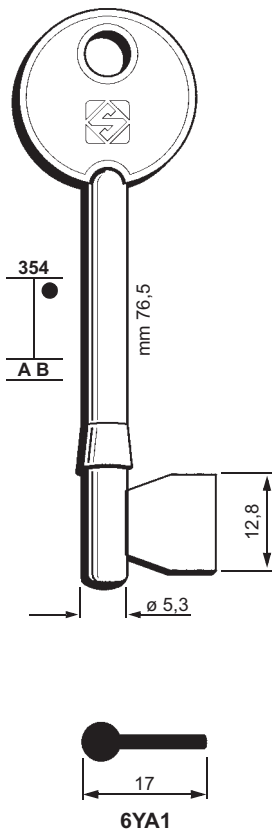

ZORATTO

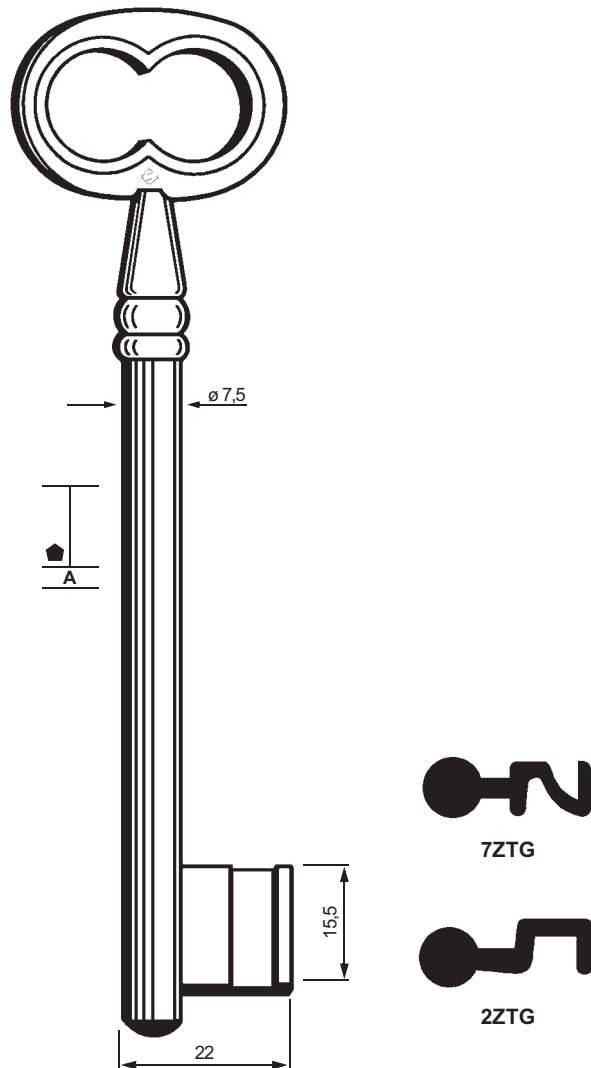

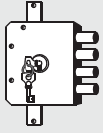

110

FOR/PER

CHIAVI ADATTABILI
MASCHI a GORGES

FOR:
PER:

CHIAVI ADATTABILI - MASCHI a GORGES

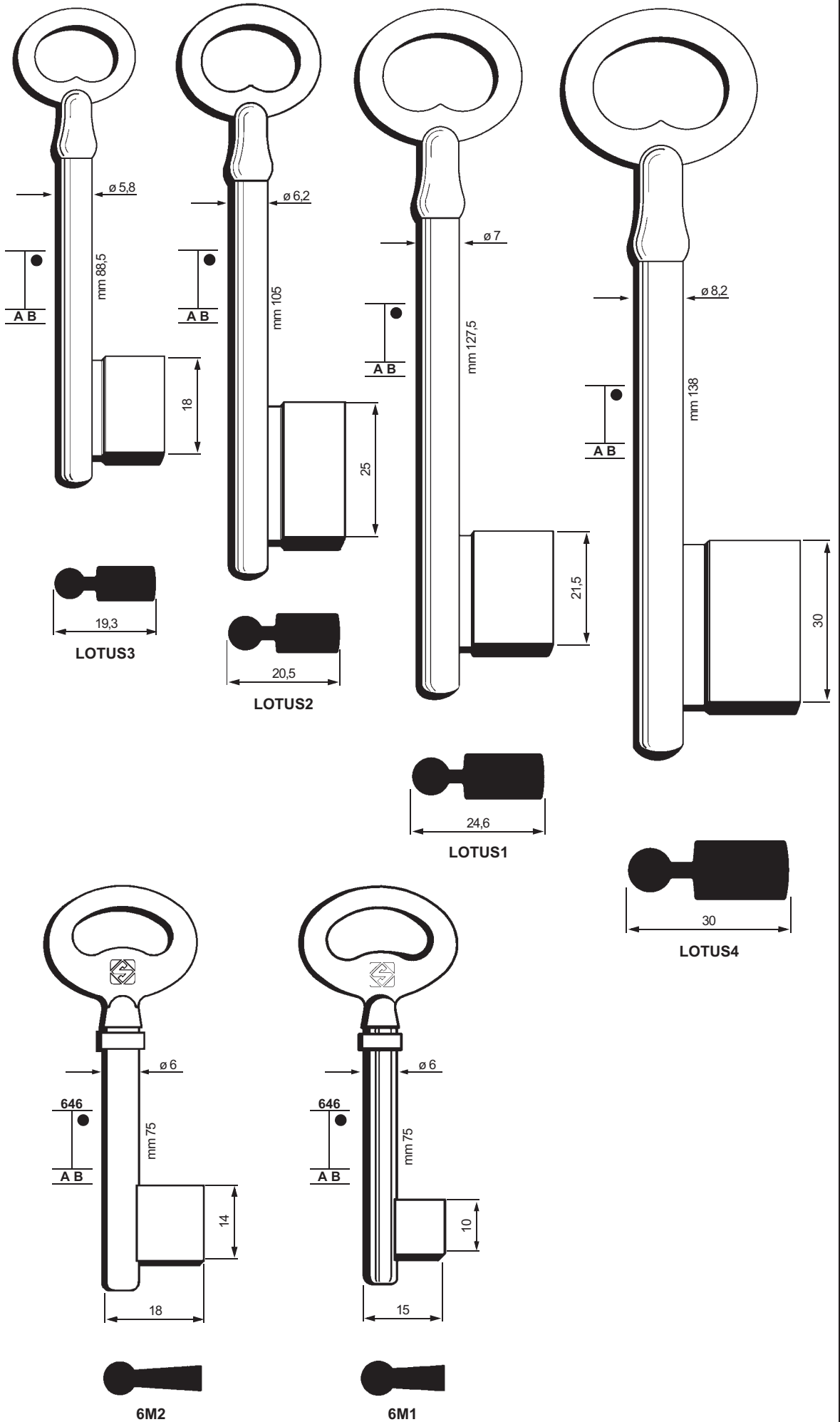

FOR:
PER:

CHIAVI ADATTABILI - FEMMINE a GORGES

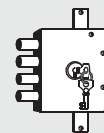

111

FOR/PER

CHIAVI ADATTABILI
FEMMINE a GORGES

FEMMINE a GORGES

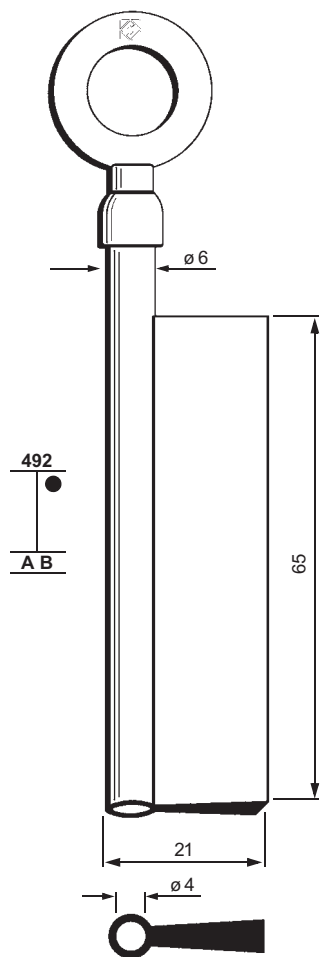

6F31

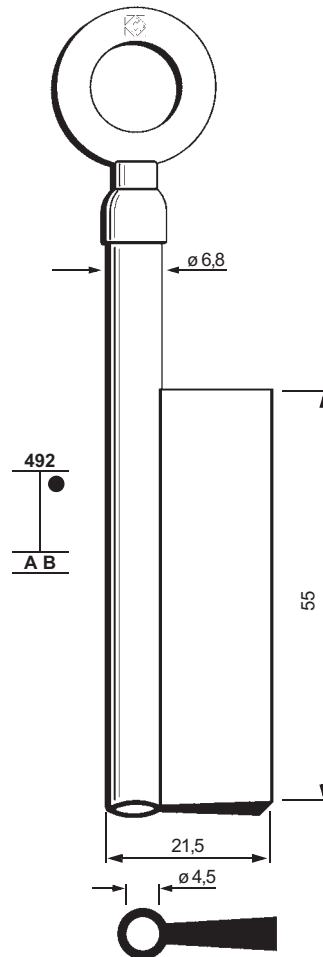

6F34

FOR:
PER:

FEMMINE a GORGES

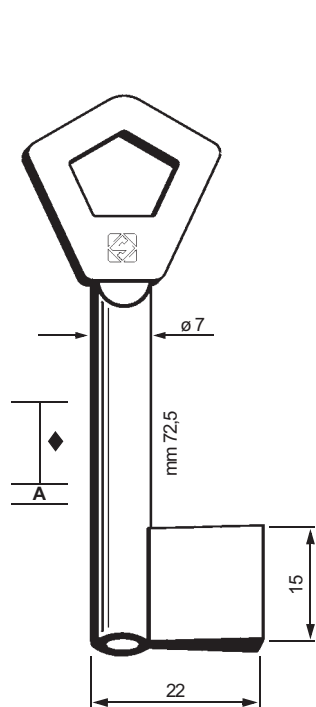

6922P4

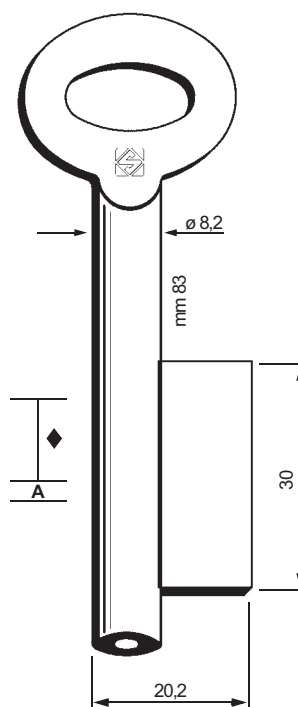

G707

GERMANY

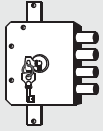

112

FOR/PER

CHIAVI ADATTABILI
MASCHI a GORGES

CHIAVI ADATTABILI
FEMMINE a GORGES

FOR:
PER:

CHIAVI ADATTABILI - MASCHI a GORGES

Art.	Ø	L
6M3	5,5	80
6M4	6	80
6M5	5	90
6M6	5,5	90
6M7	6	90
6M8	5	95
6M9	5,5	95
6M10	6	95
6M11	5	100
6M12	5,5	100
6M13	6	100
6M14	6,5	100

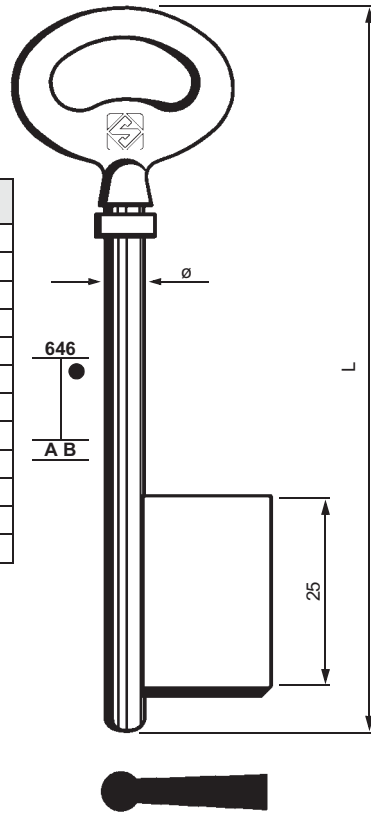

Art.	Ø	L
6M15	5	95
6M16	5,5	95
6M32	5,8	95
6M17	6	98
6M18	6,5	95
6M19	5	100
6M20	5,5	100
6M21	6	100
6M22	6,5	100
6M23	5	110
6M24	5,5	110
6M25	6	110
6M26	6,5	110
6M27	5	120
6M28	5,5	120
6M29	6	120
6M30	6,5	120
6M35	6	140

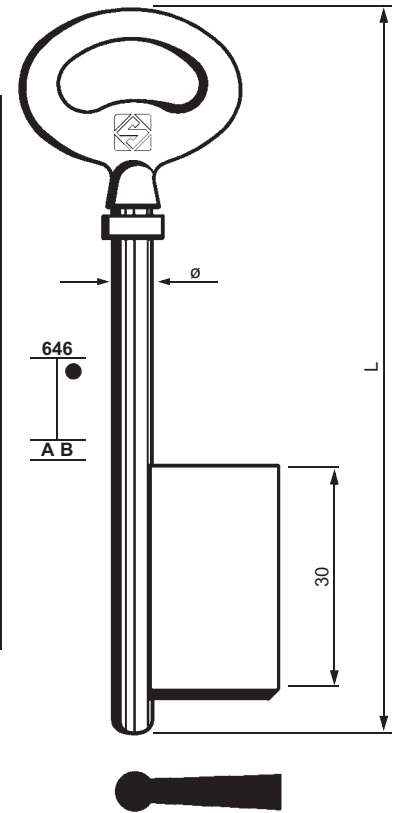

FOR:
PER:

CHIAVI ADATTABILI - FEMMINE a GORGES

Art.	Ø	L	Ø i
6F3	5,5	75	3,5
6F4	6	75	4
6F5	5	85	3
6F6	5,5	85	3,5
6F7	6	85	4
6F8	5	90	3
6F9	5,5	90	3,5
6F10	6	90	4
6F11	5	95	3
6F12	5,5	95	3,5
6F13	6	95	4
6F14	6,5	95	4

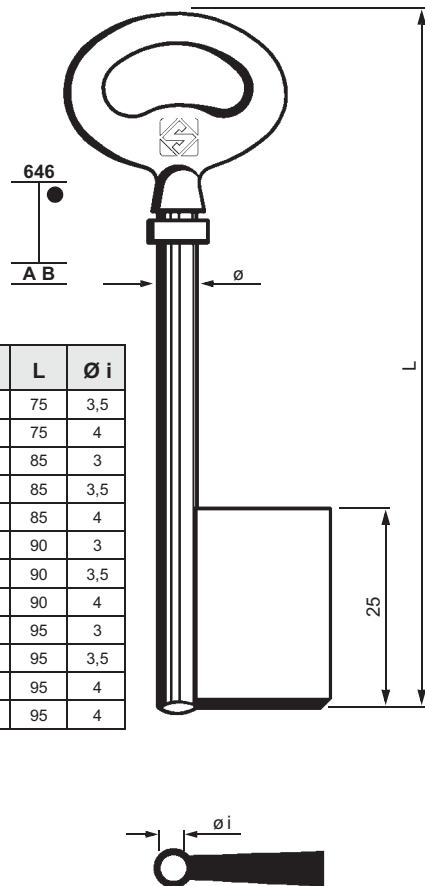

Art.	Ø	L	Ø i
6F15	5	90	3
6F16	5,5	90	3,5
6F17	6	93	4
6F18	6,5	90	4
6F19	5	95	3
6F20	5,5	95	3,5
6F21	6	95	4
6F22	6,5	95	4
6F23	5	105	3
6F24	5,5	105	3,5
6F25	6	105	4
6F26	6,5	105	4
6F27	5	115	3
6F28	5,5	115	3,5
6F29	6	115	4
6F30	6,5	115	4

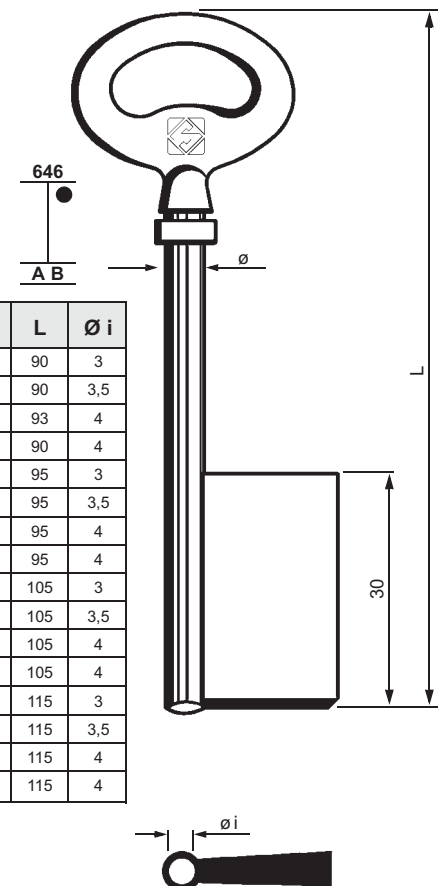

FOR:
PER:

MASCHI a GORGES

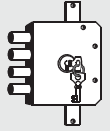

113

FOR/PER

MASCHI A GORGES

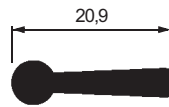
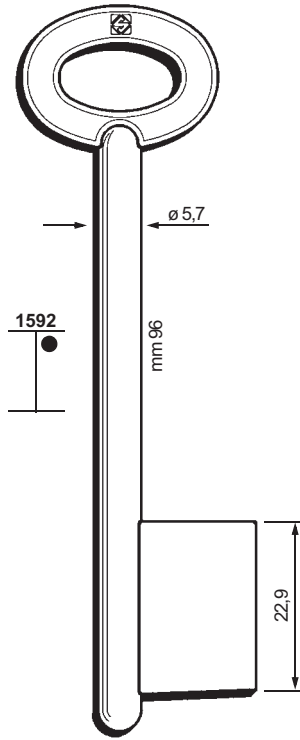

6M38

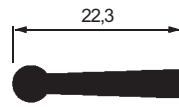
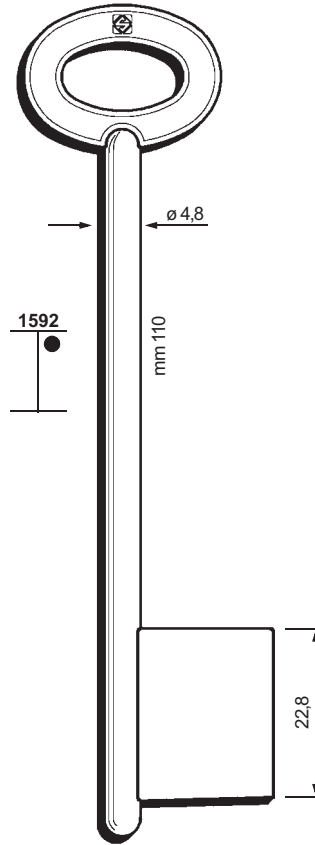

6M37

FOR:
PER:

MASCHI a GORGES

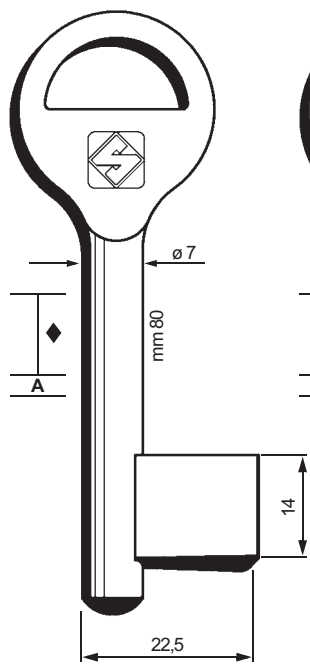

G685

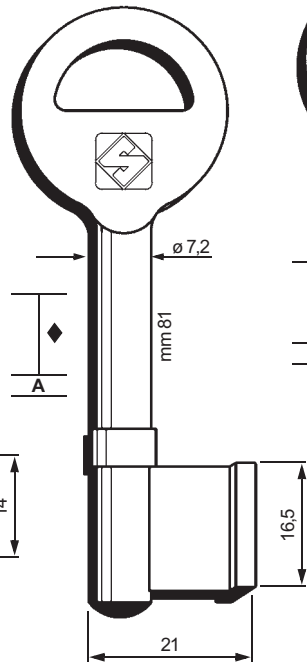

G713

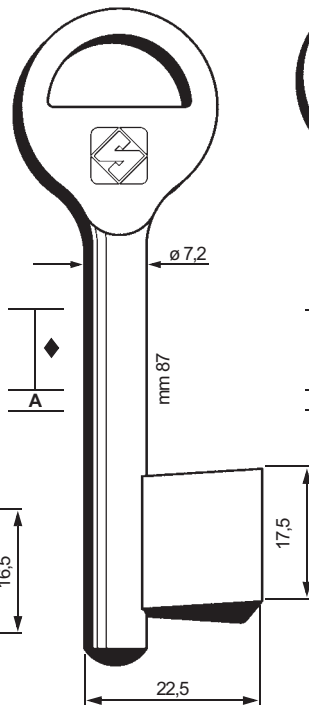

G662

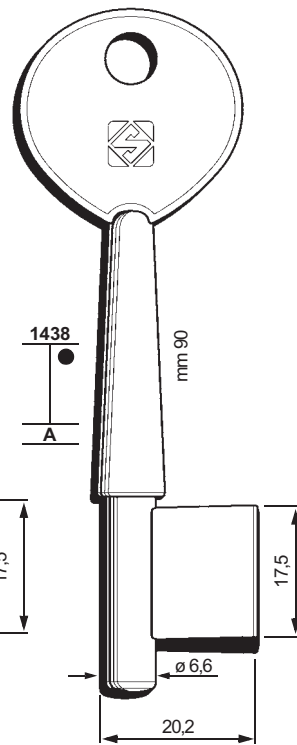

6M36

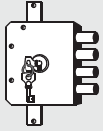

114

FOR:
PER:

MASCHI a GORGES

PER/FOR:
GLITTENBERG

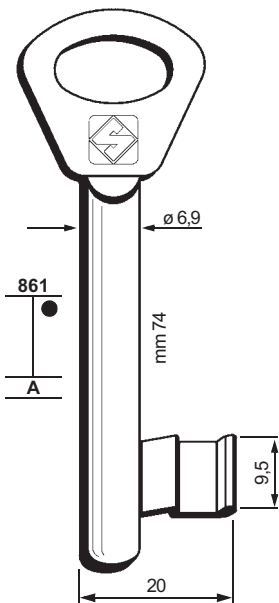

G6-1



G6-41



G6-109



G6-235



G6-2



G6-42



G6-110



G6-236



G6-9



G6-53



G6-121



G6-263



G6-10



G6-54



G6-122



G6-264



G6-13



G6-55



G6-145



G6-273



G6-14



G6-56



G6-146



G6-274



G6-15



G6-57



G6-161



G6-285



G6-16



G6-58



G6-162



G6-286



G6-21



G6-69



G6-173



G6-287



G6-22



G6-70



G6-174



G6-288



G6-31



G6-81



G6-183



G6-32



G6-82



G6-184



G6-37



G6-99



G6-217



G6-38



G6-100



G6-218

FOR:
PER:

MASCHI e FEMMINE a GORGES

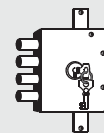

115

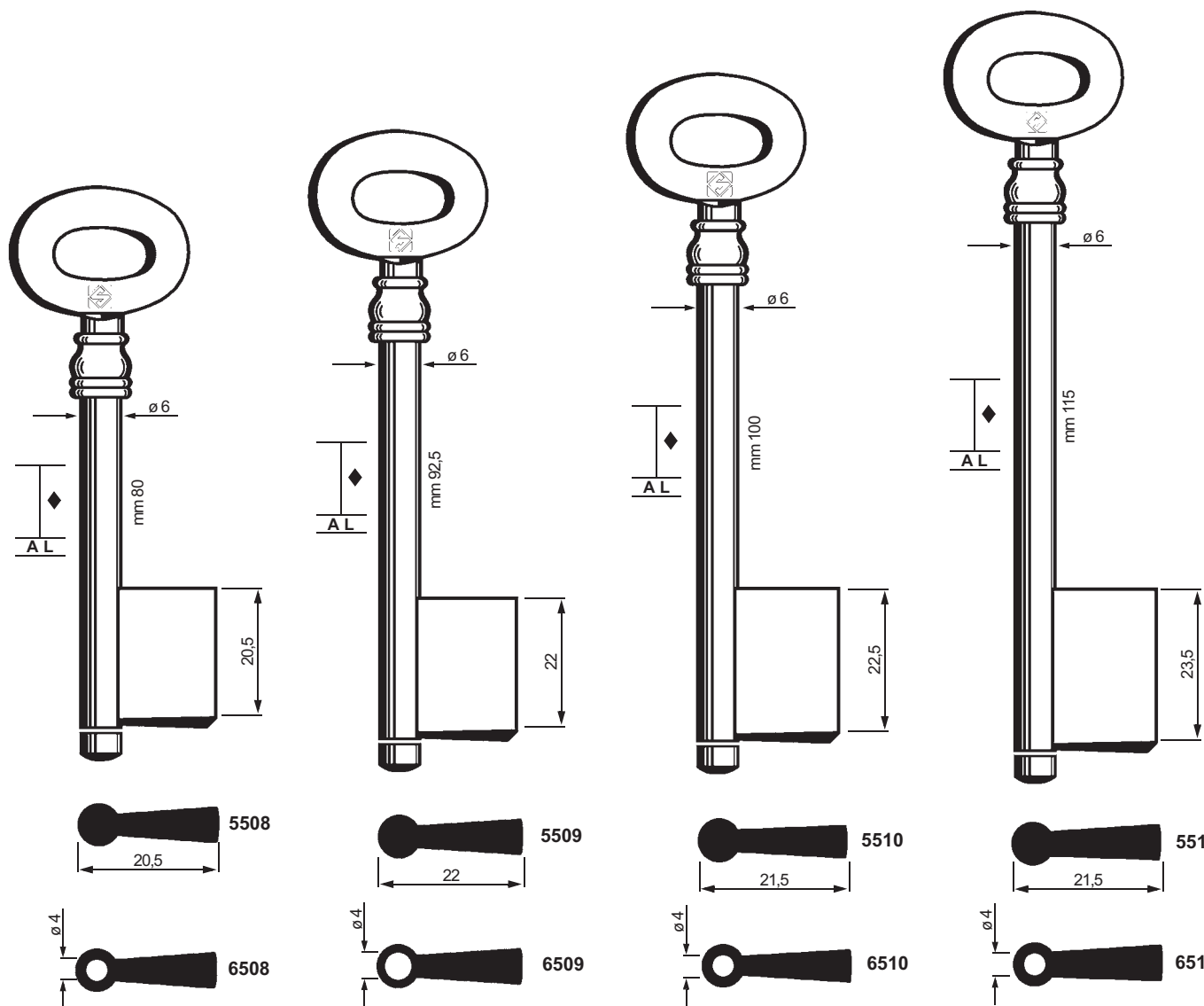

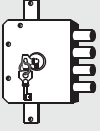

FOR:
PER:

MASCHI e FEMMINE a GORGES

116

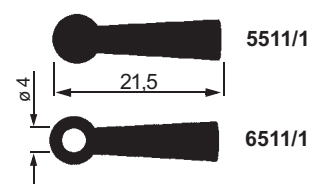
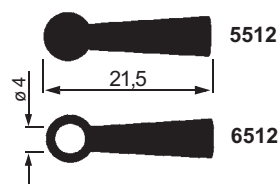
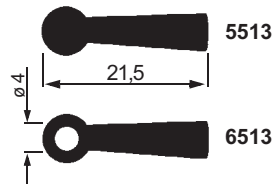
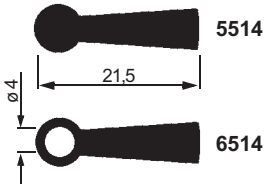
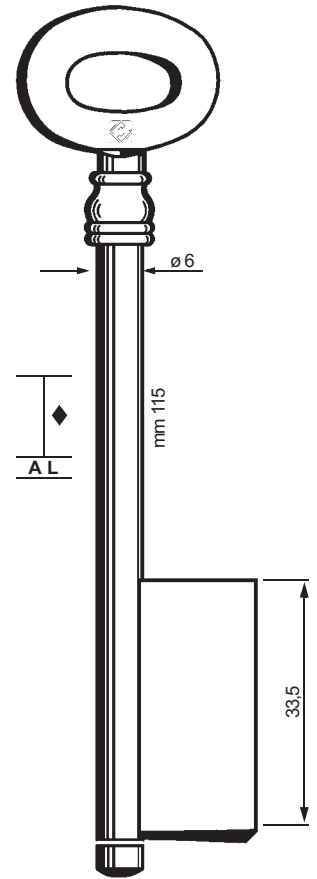
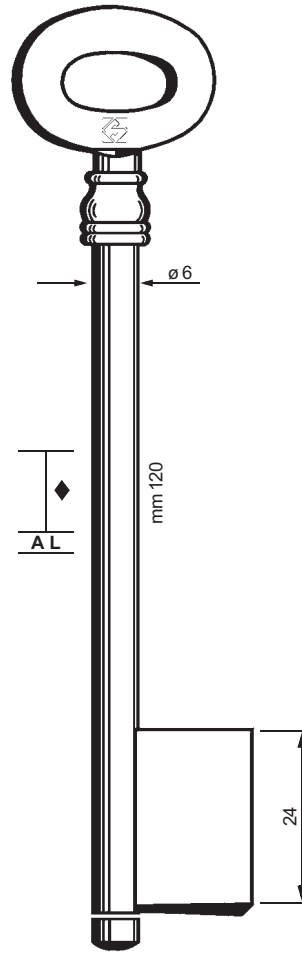
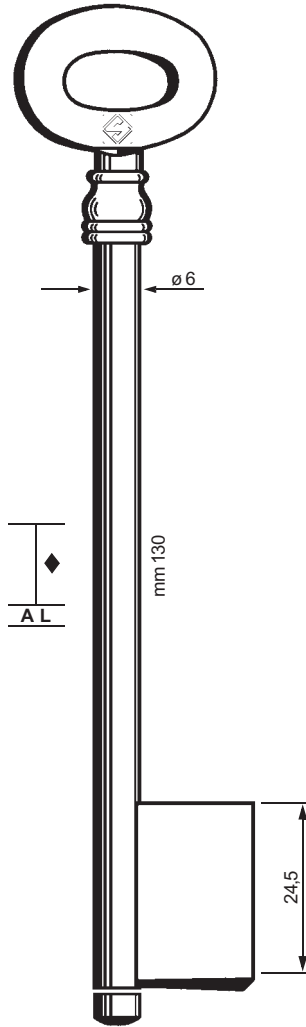
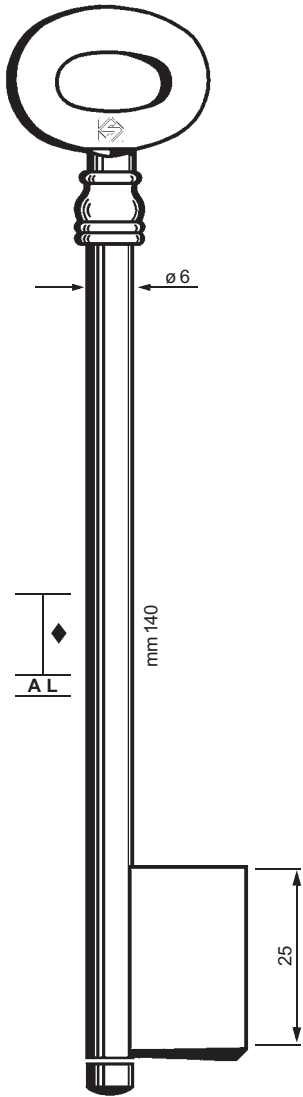

FOR:
PER:

MASCHI e FEMMINE con MAZZETTA

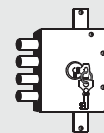

117

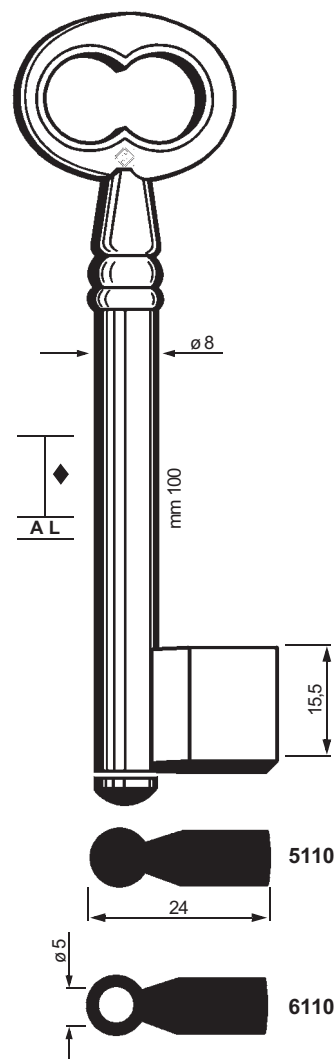
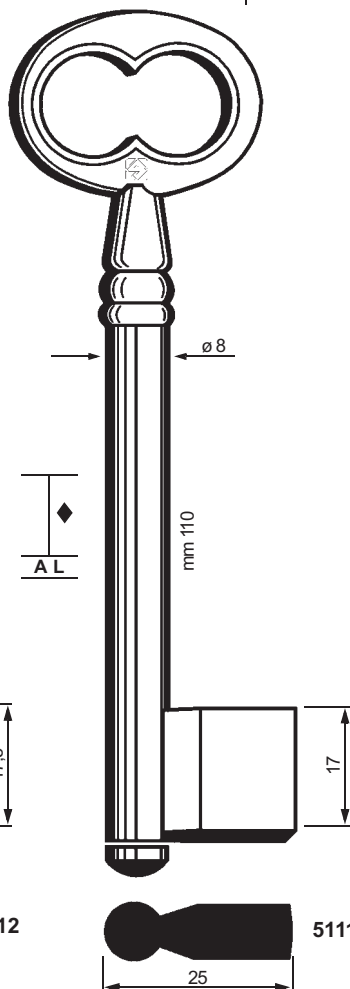
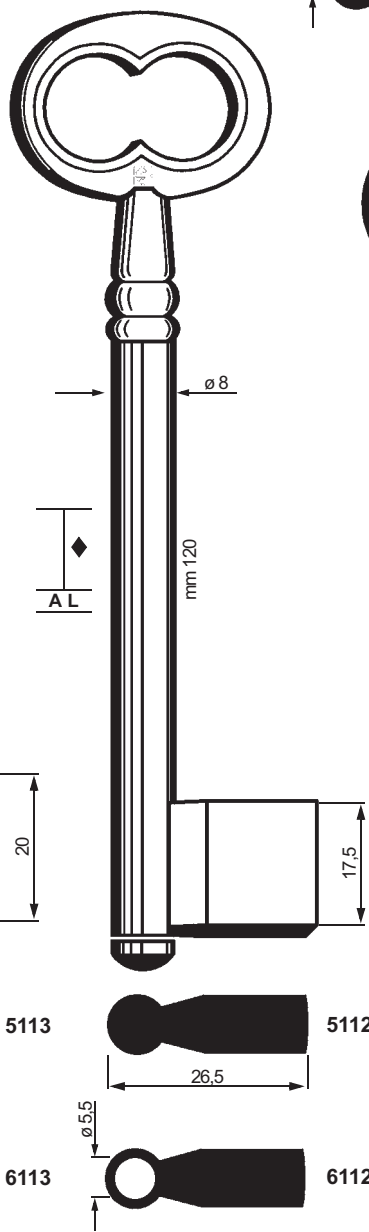
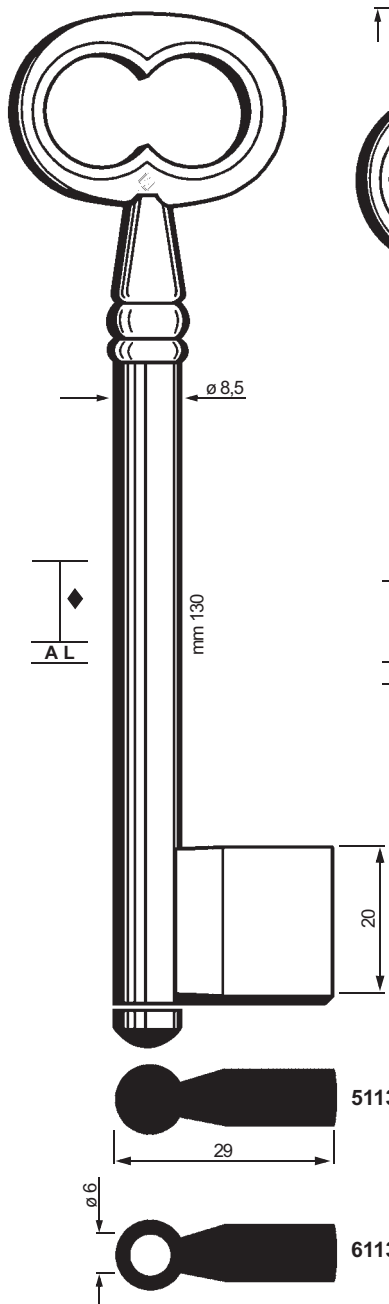
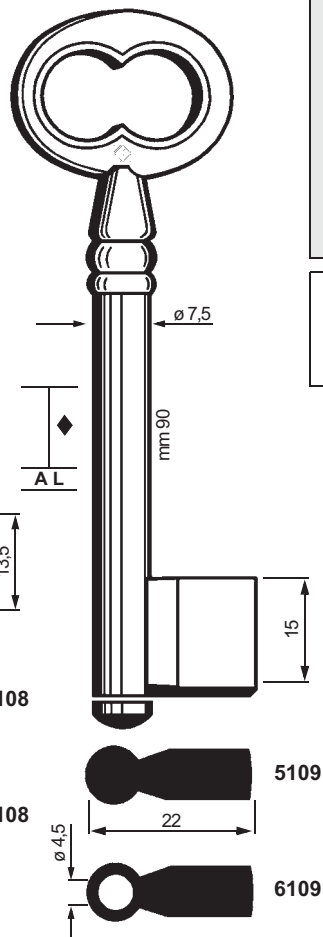
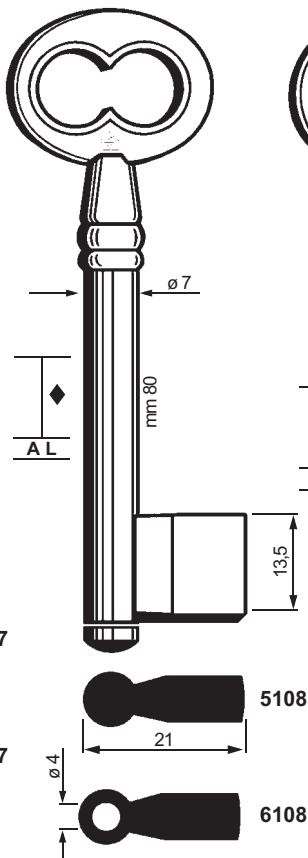
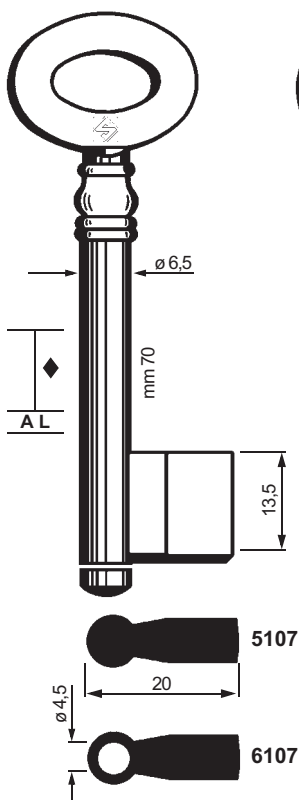
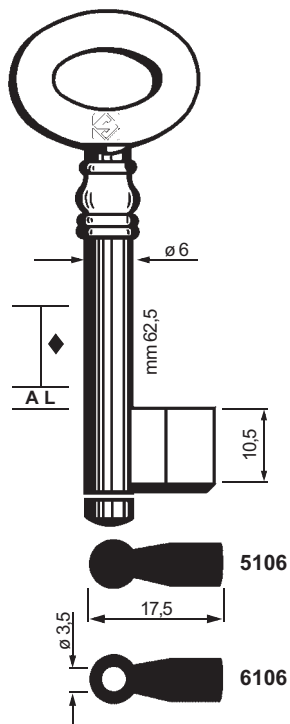

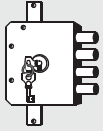

118

FOR:

PER:

MASCHI e FEMMINE con MAZZETTA

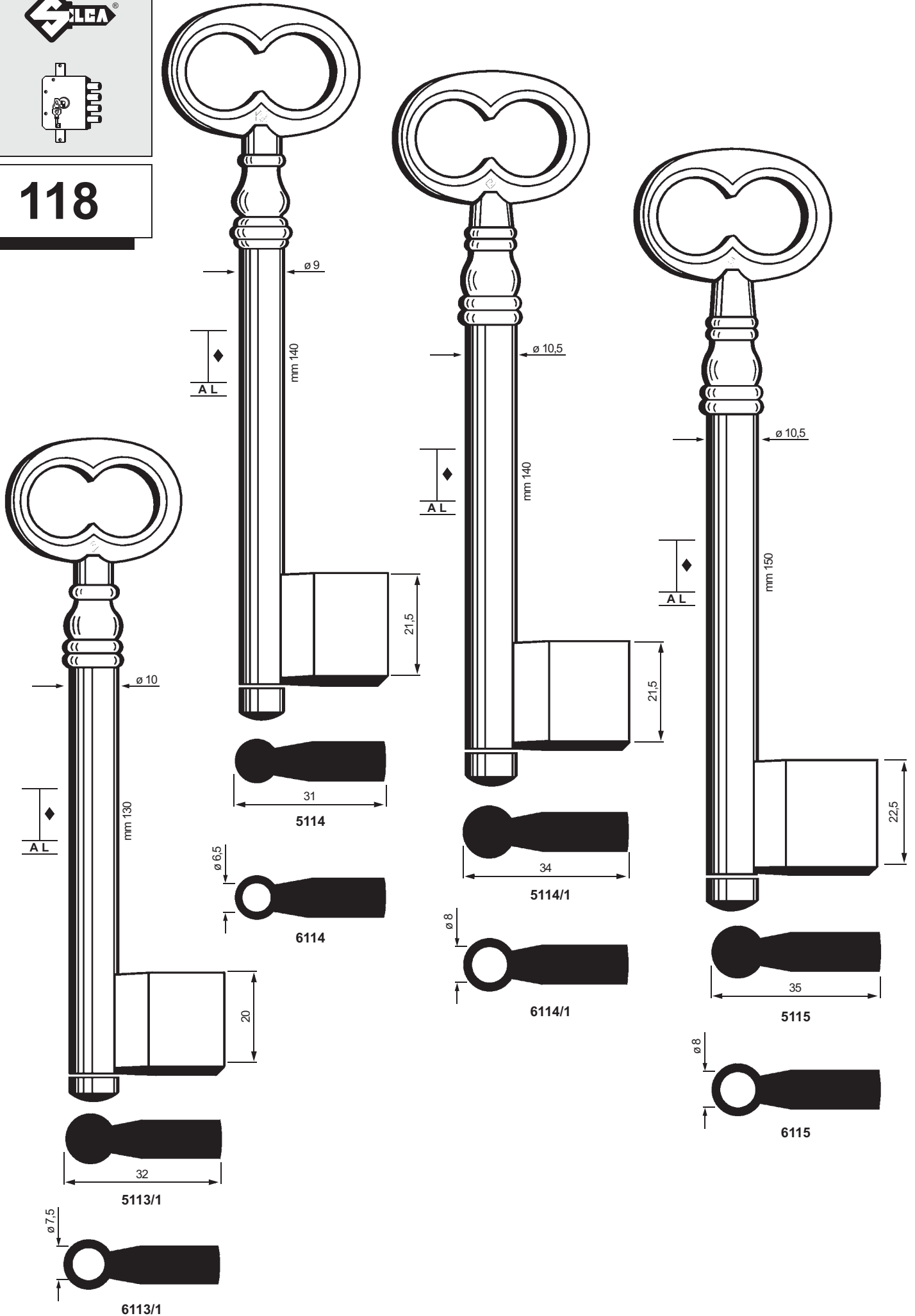

FOR:
PER:

FEMMINE FIRENZE

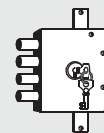

119

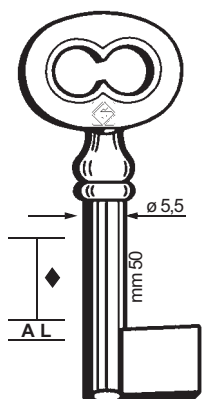

6605

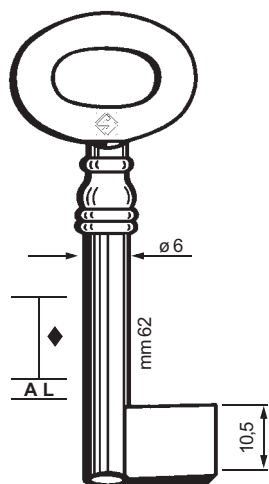

6606

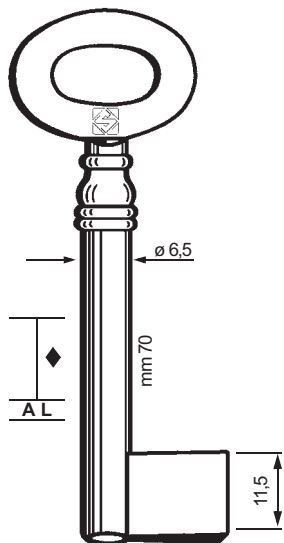

6607

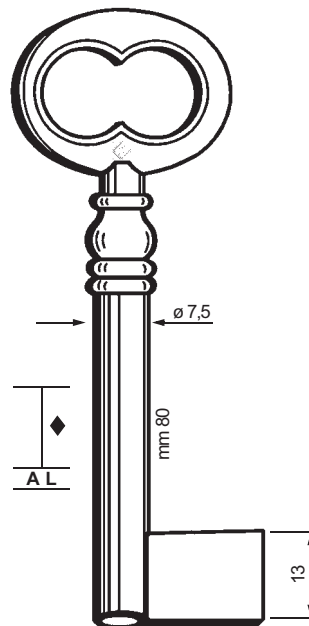

6608

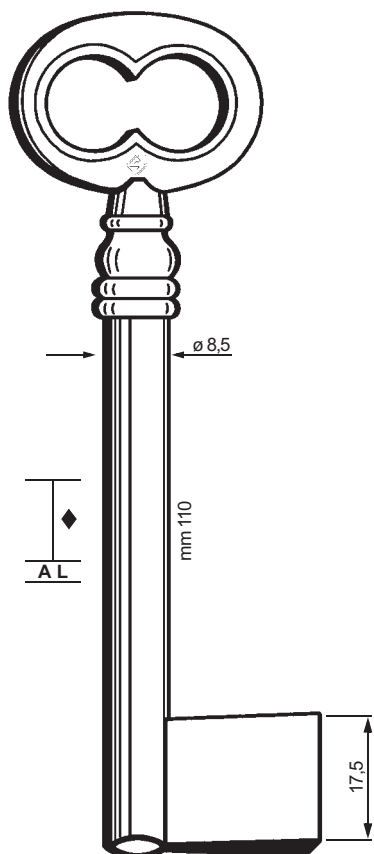

6611

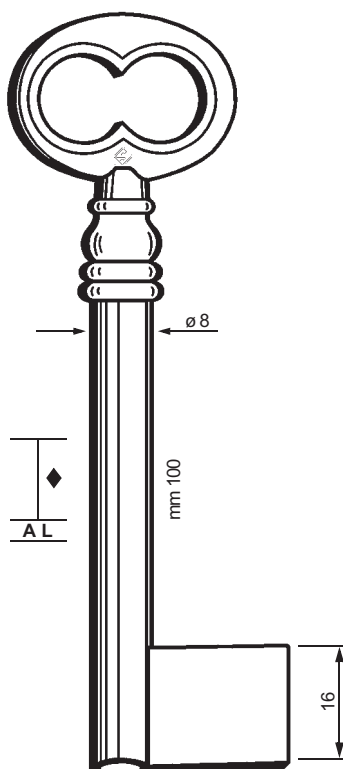

6610

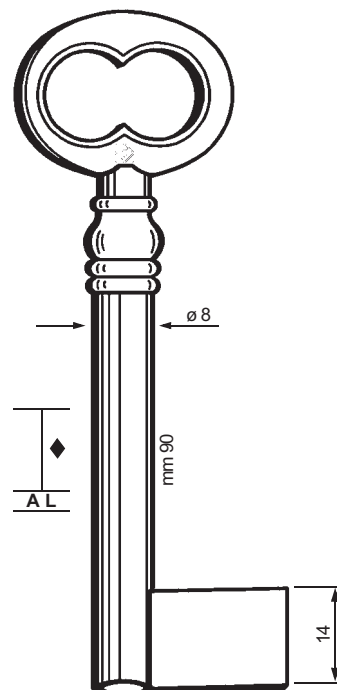

6609

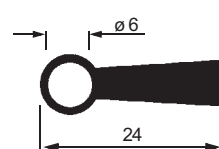
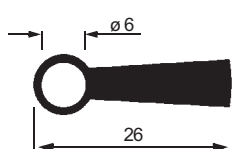
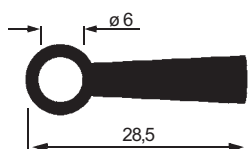

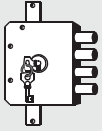

120

FOR:
PER:

FEMMINE FIRENZE

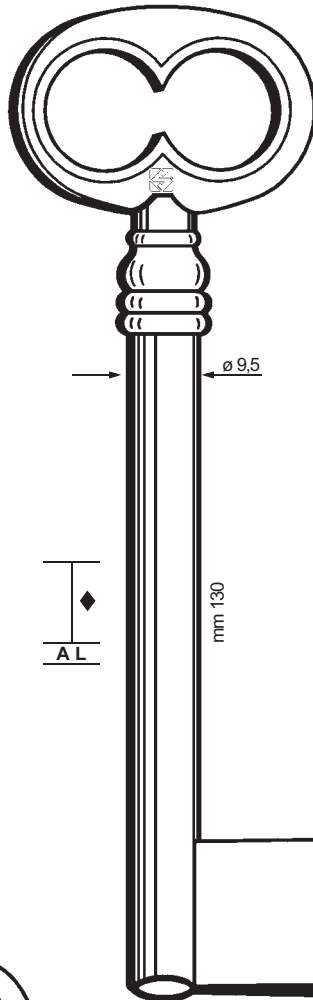

AL

mm 130

AL

mm 140

20,5

$\varnothing 7$

32

6613

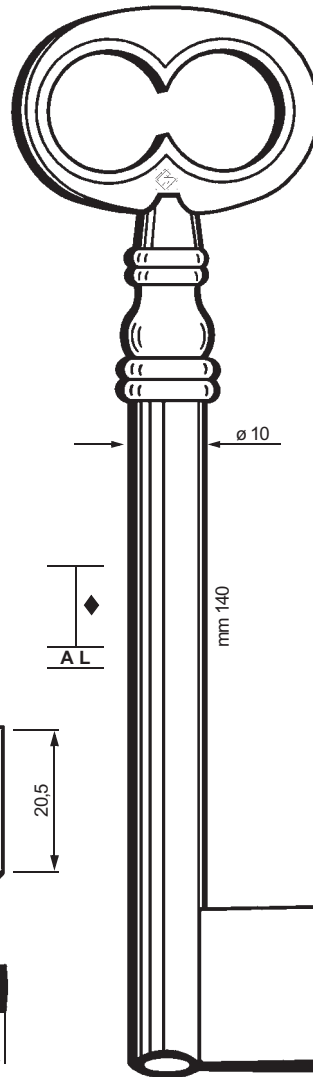

$\varnothing 10$

AL

mm 140

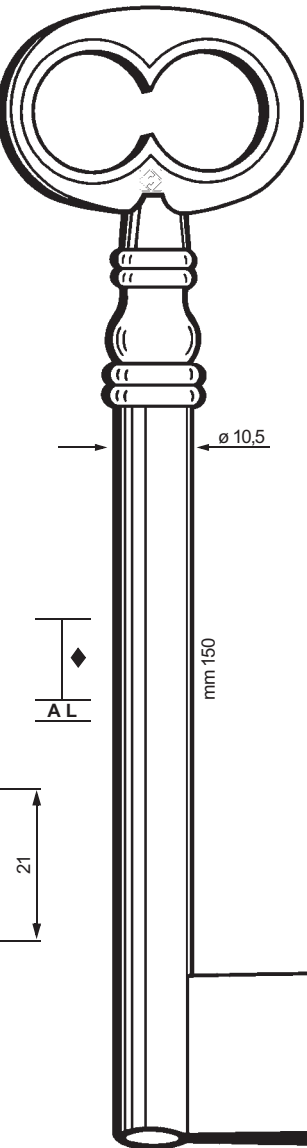

AL

mm 150

22,5

$\varnothing 9$

35

6615

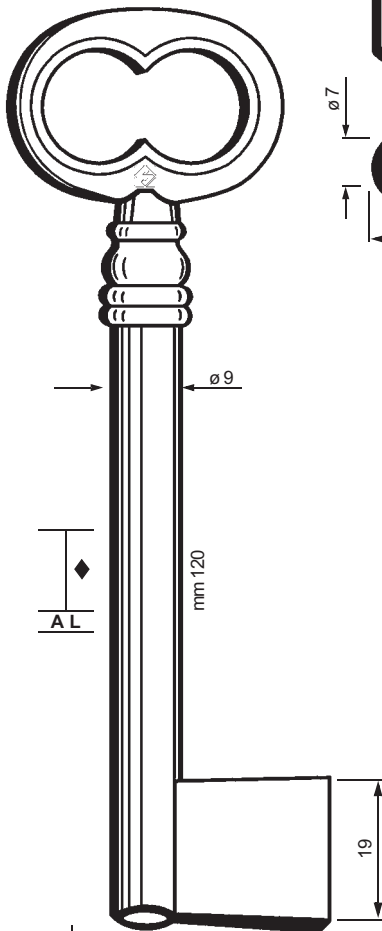

AL

mm 120

19

$\varnothing 6$

29

6612

$\varnothing 8$

34,5

6614

$\varnothing 9$

35

FOR:
PER:

MASCHI e FEMMINE

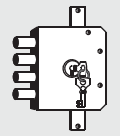

121

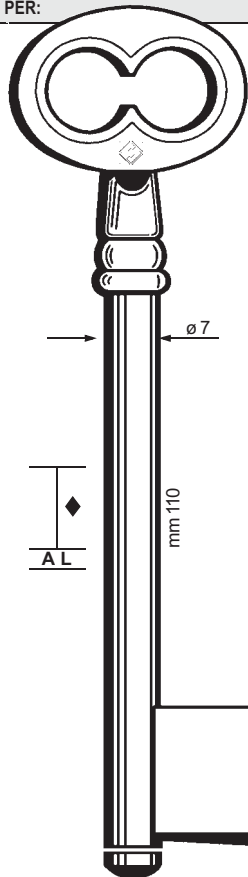

5411

alla LOMBARDA

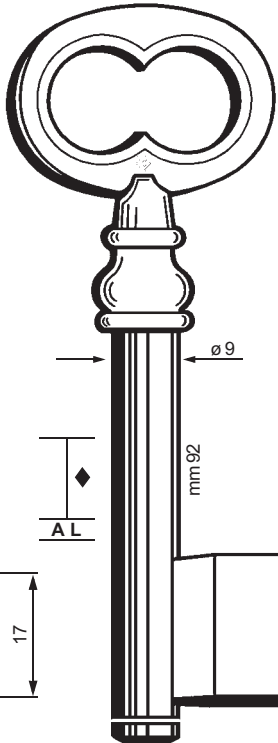

5309

per CANCELLO

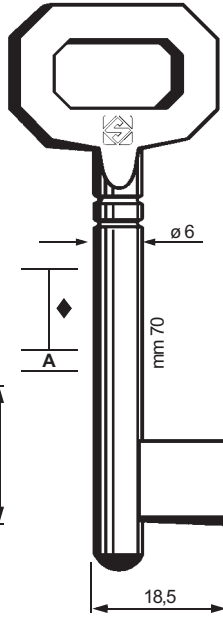

5602

tipo PATENT

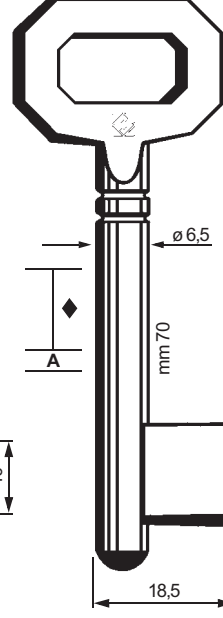

5601

tipo PATENT



6411



6309



6411



6309

FOR:
PER:

MASCHI e FEMMINE per MOBILI

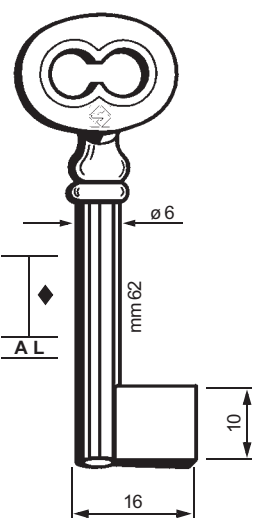

6506

ITALY

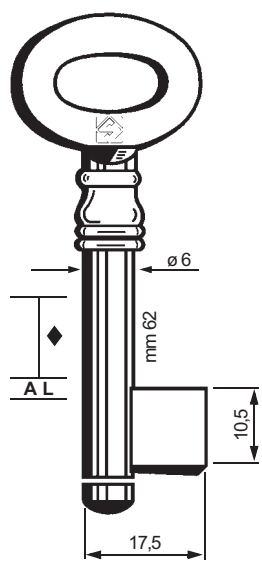

5206

ITALY

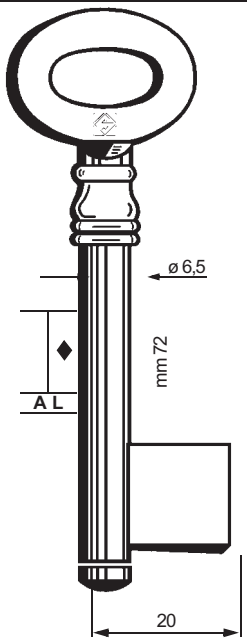

5207

ITALY

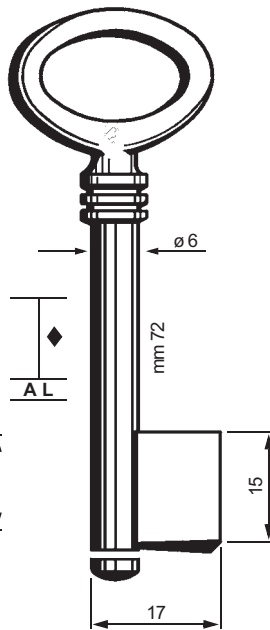

5507

FRANCE

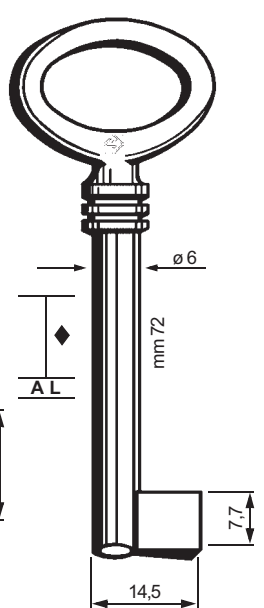

6507/1

FRANCE

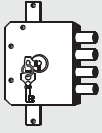

122

FOR:
PER:

MASCHI con CORONA

Art.	Ø
5818	4
5828	4,5
5838	5
5848	5,5

Art.	Ø
5817	4
5827	4,5
5837	5
5847	5,5

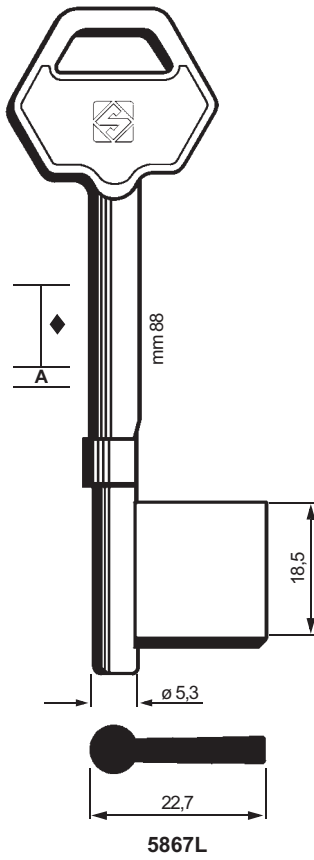

per LIPS

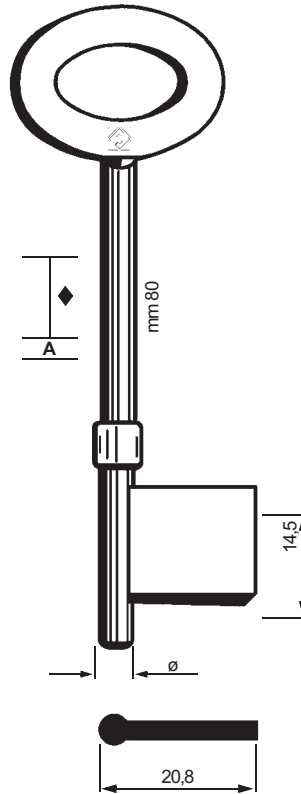

per LITTO

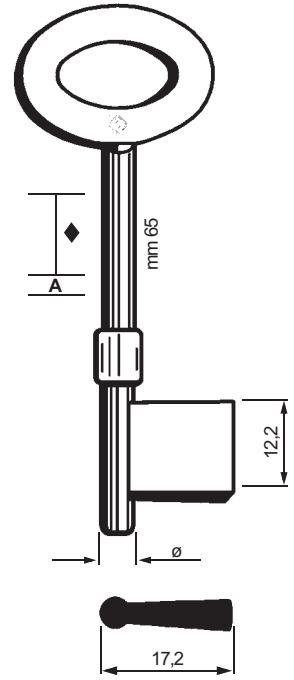

FOR:
PER:

MASCHI per CANCELLETTO

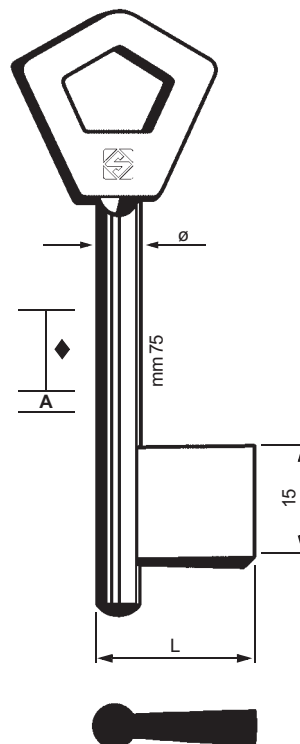
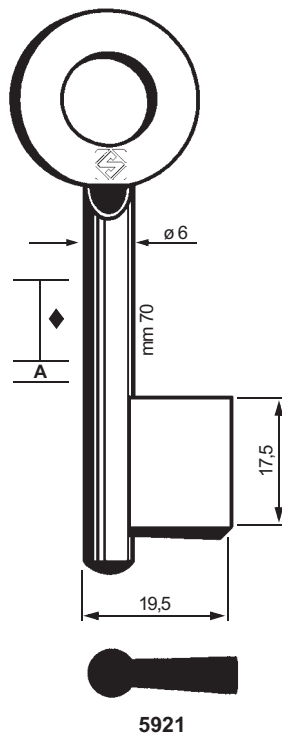
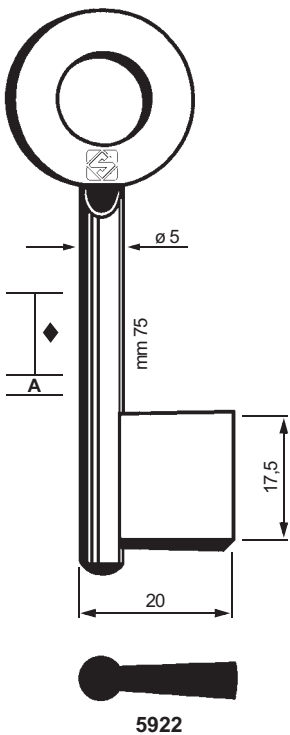

Art.	Ø	L
5922 P5	4	20,5
5922 P6	4,5	20,75
5922 P	5	21
5922 P1	5,5	21,25
5922 P2	6	21,5
5922 P3	6,5	21,75
5922 P4	7	22
5922 P7	7,5	22,25
5922 P8	8	22,5

tipo PEL

FOR:
PER:

MASCHI tipo PIEMONTE

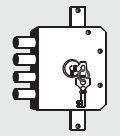

123

Art.	Ø
5908	3,5
5910	4,5

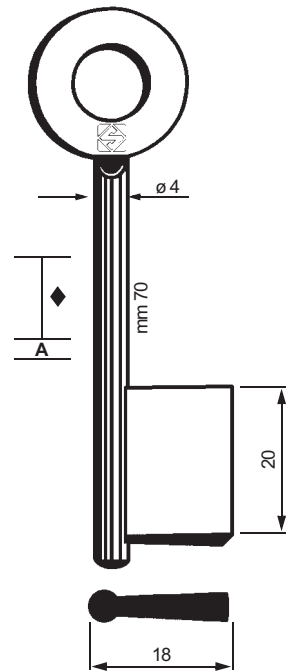
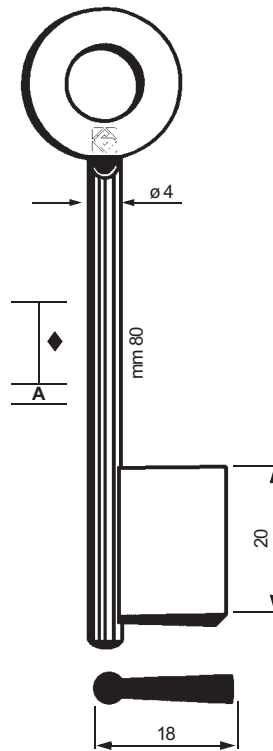
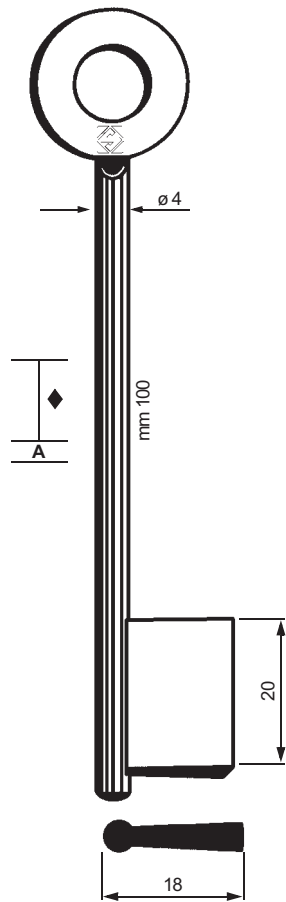
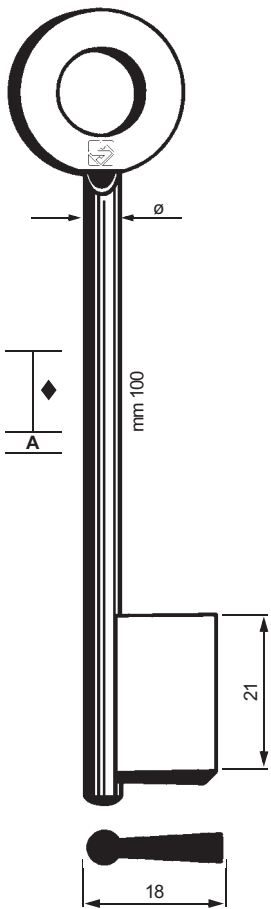

5909

5903

5901

BEC DE CAN

FOR:
PER:

MASCHI e FEMMINE da CASSETTO

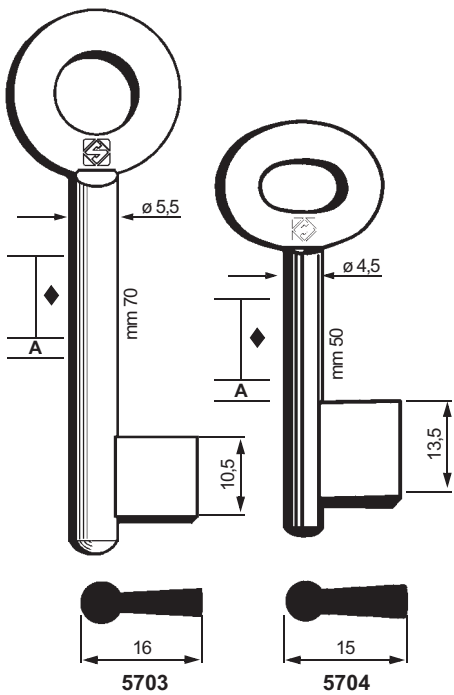

MASCHI

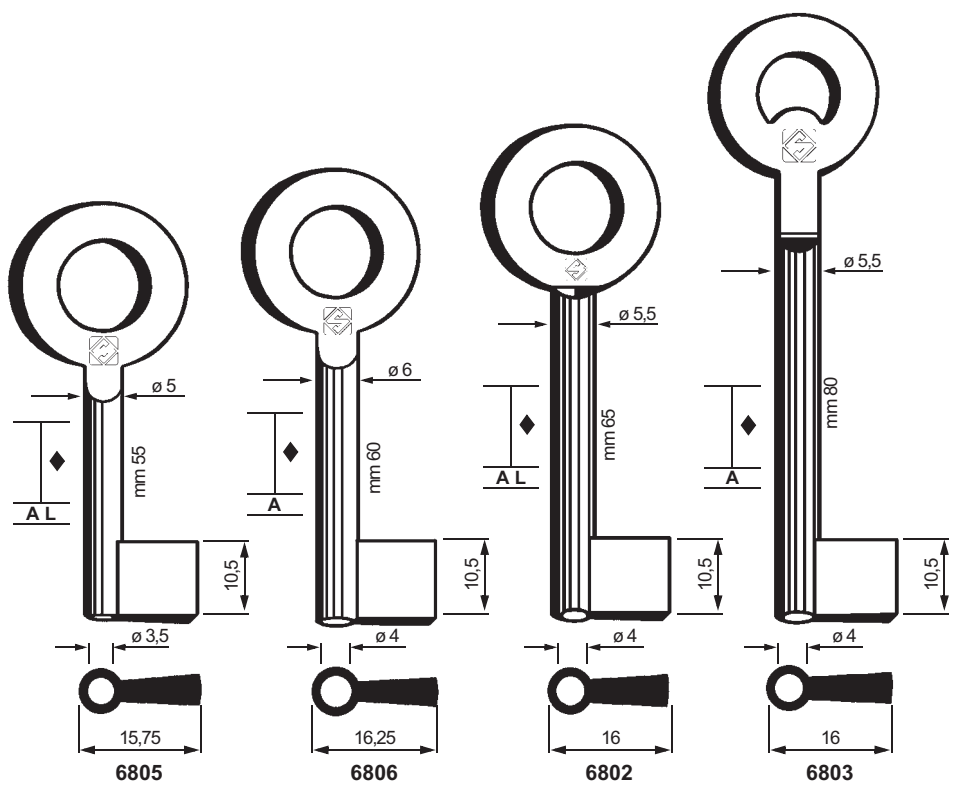

FEMMINE

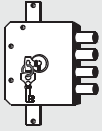

FOR:
PER:

MASCHI serie SPECIALE

124

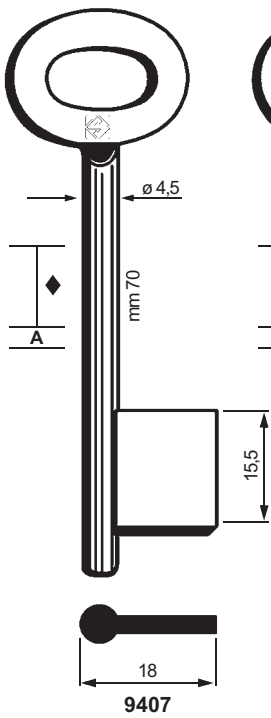

Mod. SAUDI

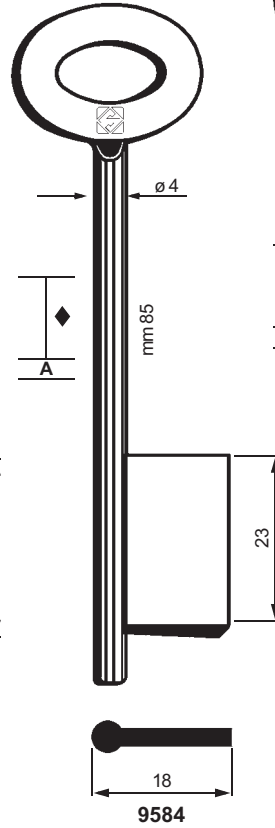
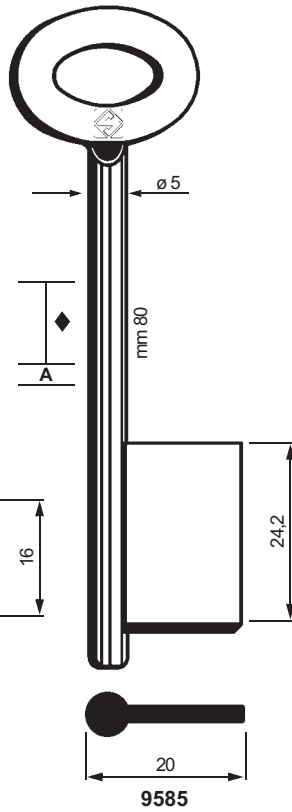
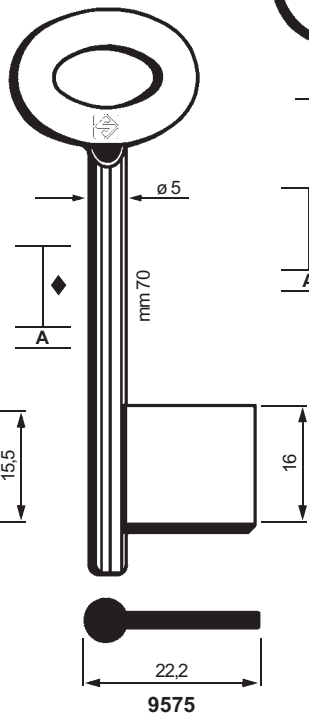

Mod. U.K.

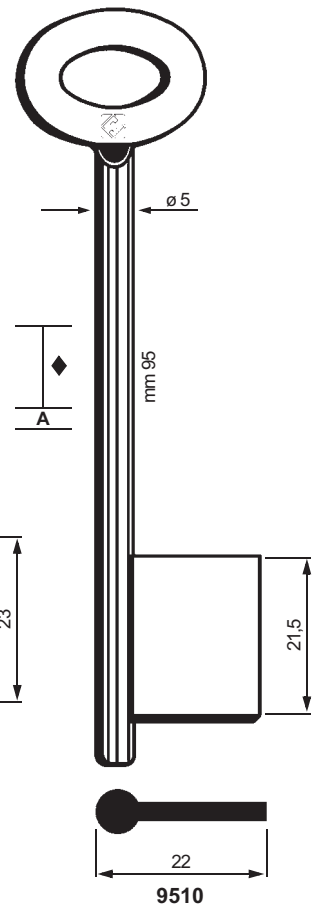

FOR:
PER:

MASCHI e FEMMINE

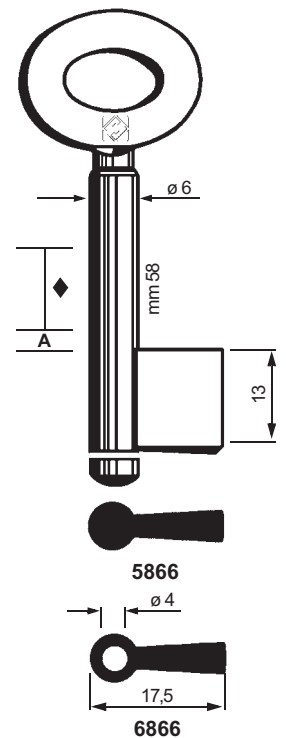
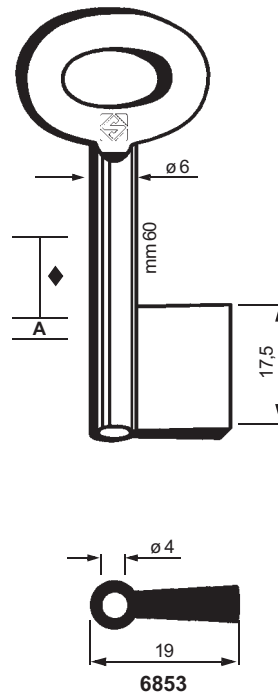
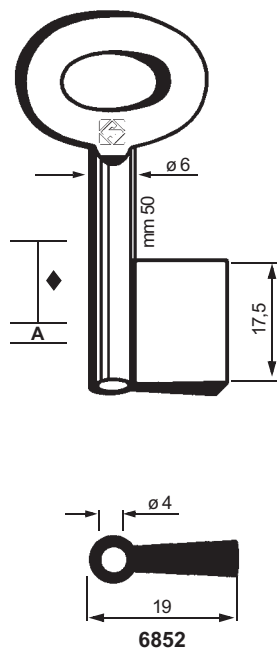
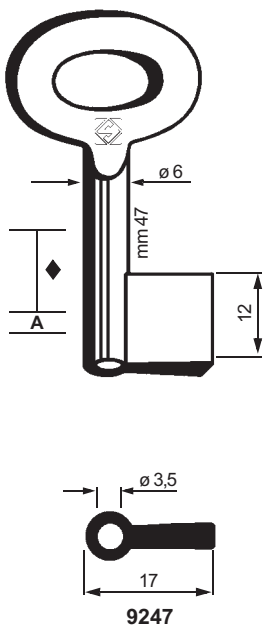

per CASSETTE PORTAVALORI

FOR:
PER:

FEMMINE

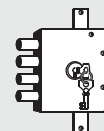

125

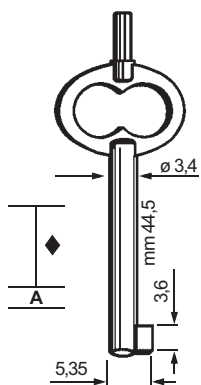

6750

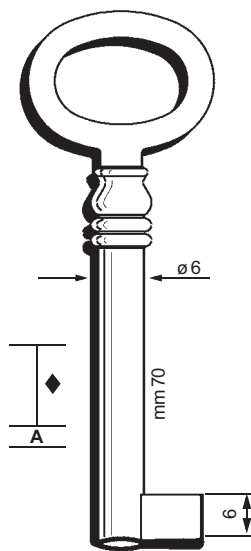

6507/4

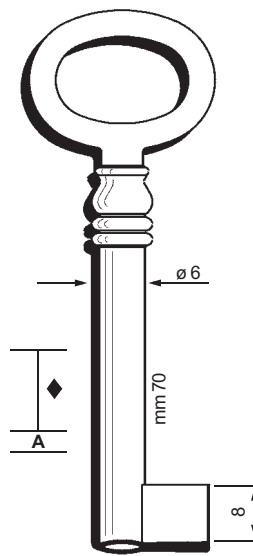

6507/2

per MANETTE
chiavi "POLICE"

GERMANY

FOR: **MASCHI e FEMMINE per SERRANDA**

MASCHI tipo TRIESTE

Art.	Tipo	\varnothing	$\varnothing i$
9107	M	7	
9207	F	7	4,5
9102	M	8	
9202	F	8	4,5

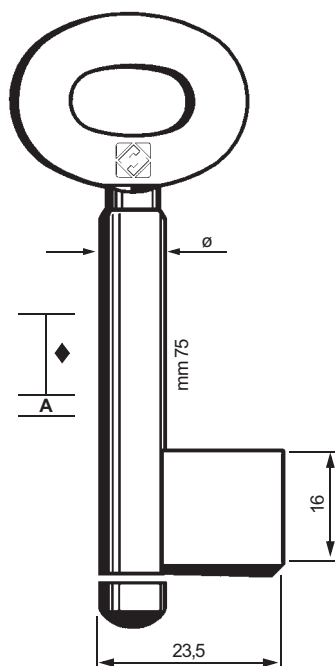

$\varnothing i$

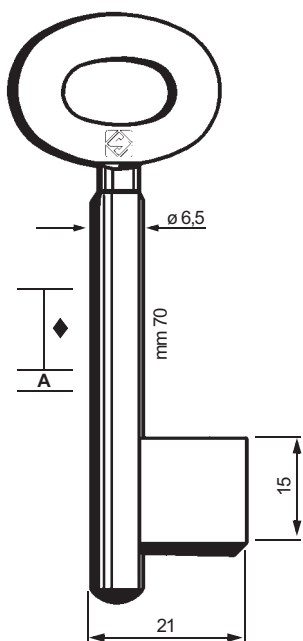

9404

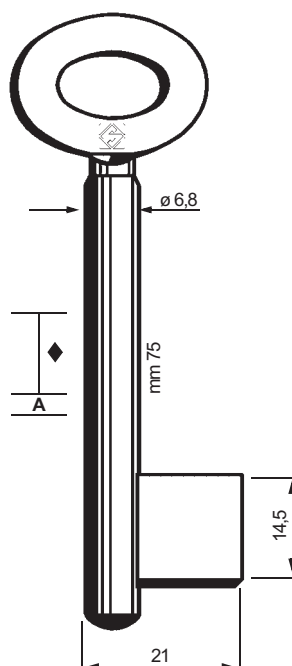

9601

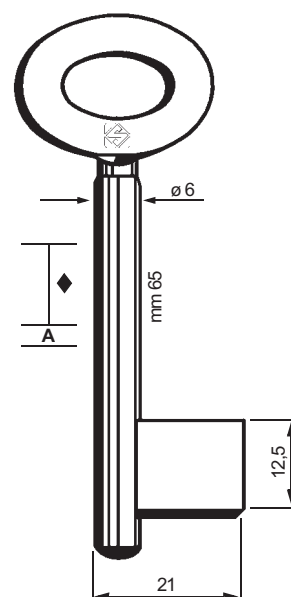

9600

per serrature Mod. WERTHEIM

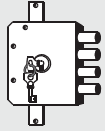

126

FOR:
PER:

MASCHI

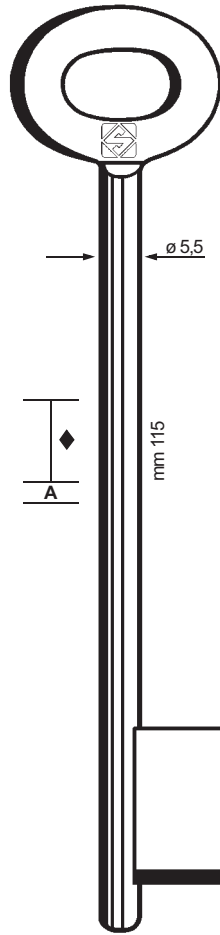

9755

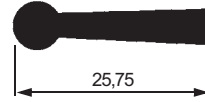
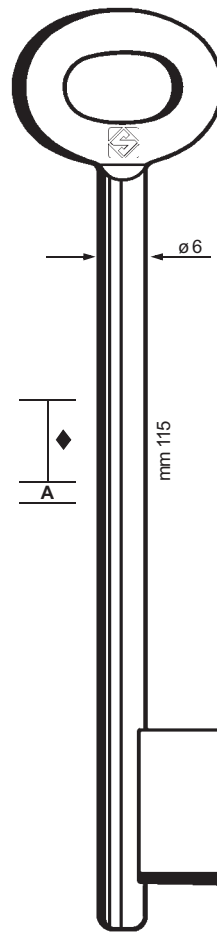

9706

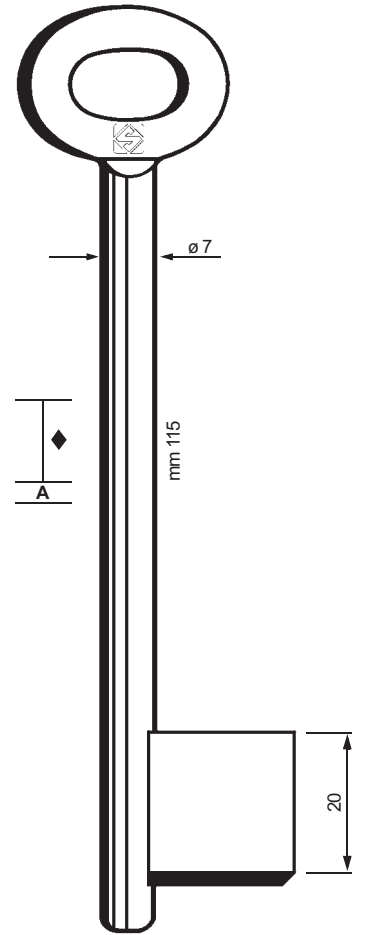

9707

Mod. BENELUX

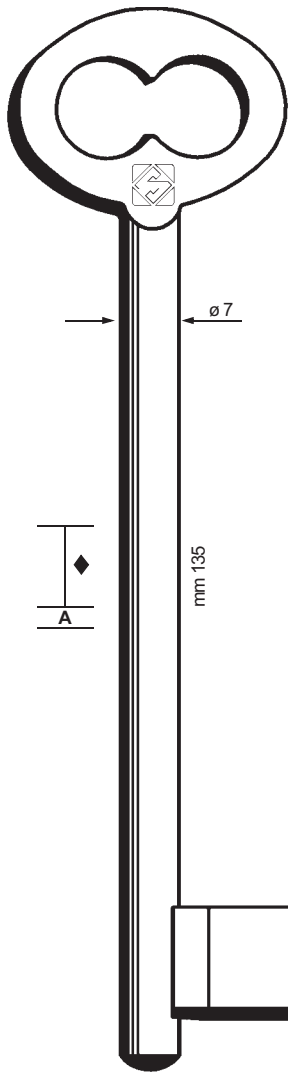

5114/2

ITALY



GB IMPORTANT

All information and illustrations in this catalogue are for guidance only.

Silca reserves the right to alter products designs, dimensions or info to improve the products quality.

The contents of this catalogue are fully protected by Copyright and may not be copied or reproduced in any form, without written permission from Silca.

Any infringements will be dealt with under Italian law.

F IMPORTANT

Les illustrations et les caractéristiques techniques des produits présentés dans ce catalogue sont données à titre indicatif.

Bien que les caractéristiques essentielles des produits soient invariables, Silca se réserve le droit d'apporter toutes les modifications qu'elle retiendra nécessaires et opportunes afin d'améliorer la qualité de ses produits.

Tous les dessins et photos sont propriété Silca et toute reproduction, même partielle, sans l'autorisation écrite préalable de Silca est interdite conformément aux prescriptions légales. Tout litige est du ressort exclusif des Tribunaux de la circonscription où se trouve le Siège de la Société.

I IMPORTANT

Le illustrazioni e i dati tecnici dei prodotti contenuti nel catalogo debbono considerarsi indicativi.

Silca si riserva il diritto, ferme restando le caratteristiche essenziali dei prodotti, di apportare tutte le modifiche che ritiene necessarie e opportune al fine di migliorare la qualità dei prodotti.

Tutti i disegni e le fotografie sono di proprietà di Silca, ogni riproduzione anche parziale, senza autorizzazione scritta della Silca è vietata secondo termini di legge.

Per qualsiasi controversia competenti sono gli Uffici Giudiziari dove ha sede l'Azienda, con espressa esclusione di qualsiasi altro foro.

E IMPORTANTE

Las ilustraciones y los datos técnicos de los productos en este catálogo son indicativos.

La Silca se reserva el derecho, quedando invariadas las características principales de los productos, de modificar todo lo que considere necesario y oportuno para mejorar la calidad de sus artículos.

Todos los dibujos y las fotografías pertenecen a la Silca; según determina la Ley, se prohíbe toda reproducción aunque parcial, sin autorización por escrito de la Silca.

En caso de disputas la competencia es de las autoridades judiciales donde está domiciliada la firma, excluyendo cualquier otro foro.

D WICHTIG

Die Abbildungen und technischen Daten des Katalogs sind nur zur Information.

Silca behält sich vor, etwaige Änderungen am Produkt, die zur Verbesserung desselben beitragen vorzunehmen.

Alle Zeichnungen und Fotos sind Besitz der Firma Silca, jede Reproduktion, auch teilweise, ist ohne schriftliche Erlaubnis der Firma Silca gesetzlich untersagt.

Im Falle von Streitfragen ist der Gerichtshof des Firmensitzes zuständig; jeder andere Gerichtshof ist ausgeschlossen.

P IMPORTANTE

As ilustrações e as características técnicas dos produtos apresentados neste catálogo são facultados a título indicativo.

Mesmo que as características essenciais dos produtos sejam invariáveis, à Silca reserva-se o direito de modificar ser necessário e oportuno los productos, afim de melhorar a sua qualidade.

Todos os desenhos e fotos são propriedade da Silca, e é proibida a sua reprodução mesmo parcial sem a autorização escrita da Silca conforme as prescrições legais.

Em caso de litígio fica desde já designado, excluindo qualquer outro, o Tribunal da comarca onde está registada a sede da Silca.

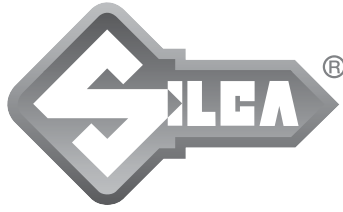
**GB IMPORTANT**

In compliance with current regulations relating to industrial property, we hereby state that the trade-marks or trade names mentioned in our catalogue are the exclusive property of authorized manufacturers of locks and users.

Said trade-marks or trade names are nominated only for the purposes of information so that any lock for which our keys are made can be rapidly identified.

This catalogue is reserved exclusively for professional key cutters who use Silca products.

I IMPORTANT

In conformità alle disposizioni legali in vigore relative alle proprietà industriali, informiamo che i marchi o le denominazioni commerciali citate nel nostro catalogo sono di proprietà esclusiva dei fabbricanti di serrature e degli utilizzatori autorizzati.

Questi marchi o denominazioni commerciali sono indicati a titolo di semplice informazione, con lo scopo di riconoscere velocemente a quali serrature le nostre chiavi sono destinate.

Questo catalogo è esclusivamente riservato ai professionisti della riproduzione chiavi che utilizzano i prodotti Silca.

D WICHTIG

Gemäß den derzeit geltenden Normen bezüglich des Industrieigentums teilen wir Ihnen mit, daß die im vorliegenden Katalog angeführten Markennamen oder Handelsmarken ausschließliches Eigentum der Schloßhersteller und zugelassenen Fachhändler sind.

Diese Markenbezeichnungen oder Handelsmarken sind nur zur Information angeführt, mit dem Zweck, schnell erkennen zu können, zu welchem Schloß unsere Schlüssel gehören.

Der vorliegende Katalog ist ausschließlich an Schlüsselkopier-Fachgeschäfte, die Silca Produkte benutzen, gerichtet.

F IMPORTANT

Conformément aux lois en vigueur concernant la propriété industrielle, nous vous informons que les marques et appellations commerciales citées dans notre catalogue appartiennent exclusivement aux fabricants de serrures et aux utilisateurs autorisés.

Ces marques ou appellations commerciales sont indiquées à titre d'information pure et simple pour vous permettre de déterminer rapidement les serrures auxquelles nos clés sont destinées.

Ce catalogue est réservé exclusivement aux professionnels du taillage de clés qui utilisent les produits Silca.

E IMPORTANTE

En conformidad con las vigentes disposiciones de ley sobre propiedad industrial, las marcas y denominaciones comerciales citadas en nuestro catálogo se declaran de propiedad exclusiva de los fabricantes de cerraduras y los utilizadores autorizados.

Dichas marcas o denominaciones comerciales se citan por simple información, al objeto de hacer comprender sin dificultad a qué cerraduras van destinadas nuestras llaves.

Este catálogo está reservado exclusivamente a los profesionales de la reproducción de llaves que utilizan los productos Silca.

P IMPORTANTE

Em conformidade com as disposições legais em vigor relativas à propriedade industrial, informamos que as marcas ou as denominações comerciais citadas no nosso catálogo são propriedade exclusiva dos fabricantes de fechaduras e dos utilizadores autorizados.

Estas marcas ou denominações comerciais são indicadas só a nível de informação, a fim de reconhecer rapidamente a quais fechaduras se destinam as nossas chaves.

Este catálogo é reservado exclusivamente aos profissionais da reprodução de chaves que utilizam os produtos Silca.